

- Preliminary Specification
- Final Specification

<b>Module</b>	<b>6.5 Inch Color TFT-LCD</b>
<b>Model Name</b>	<b>G065VN01 V2</b>

Customer	Date
_____	_____
<b>Checked &amp; Approved by</b>	
_____	_____
<p>Note: This Specification is subject to change without notice.</p>	

Approved by	Date
Leader Feng _____	2012/3/22
<b>Prepared by</b>	
Yichih Chen _____	2012/3/22
<p>General Display Business Division / AU Optronics corporation</p>	

AUO Confidential For PROMATE Internal Use Only / 2012/4/2

## Contents

<b>1. Operating Precautions</b> .....	<b>4</b>
<b>2. General Description</b> .....	<b>5</b>
2.1 Display Characteristics .....	5
2.2 Optical Characteristics .....	6
<b>3. Functional Block Diagram</b> .....	<b>8</b>
<b>4. Absolute Maximum Ratings</b> .....	<b>9</b>
4.1 Absolute Ratings .....	9
4.2 Absolute Ratings of Environment .....	9
<b>5. Electrical Characteristics</b> .....	<b>10</b>
5.1 TFT-LCD Driving .....	10
5.2 Backlight Unit Driving .....	12
<b>6. Signal Characteristic</b> .....	<b>13</b>
6.1 Pixel Format Image .....	13
6.2 Scanning Direction .....	13
6.3 The Input Data Format .....	14
6.4 TFT- LCD Interface Signal Description .....	15
6.5 TFT- LCD Interface Timing .....	16
6.6 LED Backlight Unit Interface Signal Description .....	17
6.7 Power ON/OFF Sequence .....	18
<b>7. Connector &amp; Pin Assignment</b> .....	<b>19</b>
7.1 TFT- LCD Signal (CN1): LCD Connector .....	19
7.2 LED Backlight Unit (CN2): Backlight Connector .....	19
7.3 PIN 1 definition of CN1 and CN2 .....	20
<b>8. Reliability Test Criteria</b> .....	<b>21</b>
<b>9. Mechanical Characteristics</b> .....	<b>22</b>
<b>10. Label and Packaging</b> .....	<b>23</b>
10.1 Shipping Label (on the rear side of TFT-LCD display) .....	23
10.2 Carton Package .....	23
<b>11 Safety</b> .....	<b>24</b>
11.1 Keen Edge Requirements .....	24
11.2 Materials .....	24
11.3 Capacitors .....	24
11.4 National Test Lab Requirement .....	24

## Record of Revision

Version and Date	Page	Old description	New Description	Remark																																				
0.1, Apr. 23, 2009	All	First edition preliminary specifications																																						
1.0, Oct. 22, 2009	5	Temperature Range Operating: -30 to +85 Storage (Non-Operating): -30 to +85	Temperature Range Operating: -30 to +80* Storage (Non-Operating): -30 to +80* *:Panel surface temperature	Section 2.1																																				
	6	White Luminance: Min: 500, Typ: 700	White Luminance: Min: 600, Typ: 800	Section 2.2																																				
	6	Color / Chromaticity Coordinates Red x, Red y: TBD Green x, Green y: TBD Blue x, Blue y: TBD	Color / Chromaticity Coordinates <table border="1" style="width: 100%; border-collapse: collapse;"> <thead> <tr> <th>Conditions</th> <th>Min.</th> <th>Typ.</th> <th>Max.</th> </tr> </thead> <tbody> <tr> <td>White x</td> <td>0.263</td> <td>0.313</td> <td>0.363</td> </tr> <tr> <td>White y</td> <td>0.279</td> <td>0.329</td> <td>0.379</td> </tr> <tr> <td>Red x</td> <td>0.559</td> <td>0.609</td> <td>0.659</td> </tr> <tr> <td>Red y</td> <td>0.314</td> <td>0.364</td> <td>0.414</td> </tr> <tr> <td>Green x</td> <td>0.285</td> <td>0.335</td> <td>0.385</td> </tr> <tr> <td>Green y</td> <td>0.554</td> <td>0.604</td> <td>0.654</td> </tr> <tr> <td>Blue x</td> <td>0.099</td> <td>0.149</td> <td>0.159</td> </tr> <tr> <td>Blue y</td> <td>0.055</td> <td>0.105</td> <td>0.155</td> </tr> </tbody> </table>	Conditions	Min.	Typ.	Max.	White x	0.263	0.313	0.363	White y	0.279	0.329	0.379	Red x	0.559	0.609	0.659	Red y	0.314	0.364	0.414	Green x	0.285	0.335	0.385	Green y	0.554	0.604	0.654	Blue x	0.099	0.149	0.159	Blue y	0.055	0.105	0.155	Section 2.2
	Conditions	Min.	Typ.	Max.																																				
	White x	0.263	0.313	0.363																																				
	White y	0.279	0.329	0.379																																				
	Red x	0.559	0.609	0.659																																				
	Red y	0.314	0.364	0.414																																				
Green x	0.285	0.335	0.385																																					
Green y	0.554	0.604	0.654																																					
Blue x	0.099	0.149	0.159																																					
Blue y	0.055	0.105	0.155																																					
6	Color Gamut Min: TBD	Color Gamut Min: 50%	Section 2.2																																					
9	Absolute Ratings of Environment Operating Temperature, Max: +85 Storage Temperature, Max: +85	Absolute Ratings of Environment Operating Temperature, Max: +80* Storage Temperature, Max: +80* *: Panel surface temperature	Section 4.2																																					
12	IrushLED Typ/Max: TBD	IrushLED Typ: 0.37 A, Max: 0.41 A	Section 5.2.1																																					
12	Operating Life Min: 25000, Max: 50000	Operating Life Min: 50000	Section 5.2.1																																					
17	LED Backlight Unit Interface Signal Description Pin 5 LED On/Off: 3.3V-On; 0V-Off	LED Backlight Unit Interface Signal Description Pin 5 LED On/Off: 3.3V-On; 0V/NC-Off	Section 6.6																																					
21	Reliability Test Criteria High Temperature Operation: 85□, 300Hr High Temperature Storage: 85□, 300Hr Thermal Shock Test: -20□/30 min, 60□/30 min, 100cycles Hot Start Test: 85°C/1 Hr (min.), power on/off per 5 minutes, repeat 5 times	Reliability Test Criteria High Temperature Operation: 80□*, 300Hr High Temperature Storage: 80□*, 300Hr Thermal Shock Test: -30□/30 min, 80□/30 min, 100cycles Hot Start Test: 80°C*1 Hr (min.), power on/off per 5 minutes, repeat 5 times *: Panel surface temperature	Section 8																																					
1.1, Mar. 22, 2012	12	V <sub>LED On/Off</sub> and V <sub>PWM</sub> range	V <sub>LED On/Off</sub> and V <sub>PWM</sub> range	Section 5.2.1																																				
		<table border="1" style="width: 100%; border-collapse: collapse;"> <tbody> <tr> <td>V<sub>LED On/Off</sub></td> <td>On Control Voltage</td> <td>3.3</td> <td>Volt</td> </tr> <tr> <td></td> <td>Off Control Voltage</td> <td>0</td> <td>Volt</td> </tr> <tr> <td rowspan="2">V<sub>PWM</sub></td> <td>Dimming control Voltage High</td> <td>3.0</td> <td>5.5</td> </tr> <tr> <td>Dimming control Voltage Low</td> <td>0</td> <td>0.1</td> </tr> </tbody> </table>	V <sub>LED On/Off</sub>		On Control Voltage	3.3	Volt		Off Control Voltage	0	Volt	V <sub>PWM</sub>	Dimming control Voltage High	3.0	5.5	Dimming control Voltage Low	0	0.1	<table border="1" style="width: 100%; border-collapse: collapse;"> <tbody> <tr> <td>V<sub>LED On/Off</sub></td> <td>On Control Voltage</td> <td>3.0</td> <td>3.3</td> <td>5.0</td> <td>Volt</td> </tr> <tr> <td></td> <td>Off Control Voltage</td> <td>0</td> <td></td> <td>0.15</td> <td>Volt</td> </tr> <tr> <td rowspan="2">V<sub>PWM</sub></td> <td>Dimming control Voltage High</td> <td>3.0</td> <td>3.3</td> <td>5.0</td> <td>Volt</td> </tr> <tr> <td>Dimming control Voltage Low</td> <td>0</td> <td></td> <td>0.1</td> <td>Volt</td> </tr> </tbody> </table>	V <sub>LED On/Off</sub>	On Control Voltage	3.0	3.3	5.0	Volt		Off Control Voltage	0		0.15	Volt	V <sub>PWM</sub>	Dimming control Voltage High	3.0	3.3	5.0	Volt	Dimming control Voltage Low	0	
V <sub>LED On/Off</sub>	On Control Voltage	3.3	Volt																																					
	Off Control Voltage	0	Volt																																					
V <sub>PWM</sub>	Dimming control Voltage High	3.0	5.5																																					
	Dimming control Voltage Low	0	0.1																																					
V <sub>LED On/Off</sub>	On Control Voltage	3.0	3.3	5.0	Volt																																			
	Off Control Voltage	0		0.15	Volt																																			
V <sub>PWM</sub>	Dimming control Voltage High	3.0	3.3	5.0	Volt																																			
	Dimming control Voltage Low	0		0.1	Volt																																			

## 1. Operating Precautions

- 1) Display area (Polarizer) of TFT-LCD Module is easily to be damaged, please be cautious and not to scratch it.
- 2) Be sure to power off your machine before connecting or disconnecting your signal cable to TFT-LCD Module.
- 3) Wipe off water drop on display area immediately. Long contact with water may cause discoloration or spots.
- 4) When the panel surface is soiled, wipe it with absorbent cotton or soft cloth.
- 5) Display area (Glass) of TFT-LCD Module may be broken or cracked if bump Module against hard object.
- 6) To avoid ESD (Electro Static Discharge) damage, be sure to ground yourself before handling TFT-LCD Module.
- 7) Do not open nor modify the TFT-LCD module assembly.
- 8) Do not press the reflector sheet at the back of the module to any direction.
- 9) In case if TFT-LCD module has to be put back into the packing container slot after it was taken out from the container, do not press the center of the LED Reflector edge. Instead, press at the far ends of the LED Reflector edge softly. Otherwise the TFT-LCD Module may be damaged.
- 10) When inserting or removing of your signal cable to TFT-LCD Module, be sure not to apply abnormal force (rotate, tilt... etc.) to the Connector of the TFT-LCD Module.
- 11) TFT-LCD Module is not allowed to be twisted & bent even force is added on module in a very short time. Please design your display product well to avoid external force applying to module by end-user directly.
- 12) Small amount of materials without flammability grade are used in the TFT-LCD module. The TFT-LCD module should be supplied by power complied with requirements of Limited Power Source (IEC60950 or UL1950), or be applied exemption.
- 13) Severe temperature condition may result in different luminance, response time.
- 14) Continuous operating TFT-LCD Module under high temperature environment may accelerate LED light bar exhaustion and reduce luminance dramatically.
- 15) The data on this specification sheet is applicable when TFT-LCD module is placed in landscape position.
- 16) Continuous displaying fixed pattern may induce image sticking. It's recommended to use screen saver or moving content periodically if fixed pattern is displayed on the screen.

## 2. General Description

G065VN01 V2 is designed for industrial display applications with VGA (640 x RGB x 480) resolution and 16.2M (RGB 6-bits + FRC) or 262k colors (RGB 6-bits). It is composed of a TFT-LCD panel, driver ICs, control and power supply circuits board and a backlight unit including LED driving circuit. G065VN01 V2 offers LVDS interface for display signal input.

### 2.1 Display Characteristics

The following items are G065VN01 V2 characteristics summary at 25 °C (Room Temperature).

Items	Unit	Specifications
Screen Diagonal	inch	6.5
Active Area	mm	132.48(H) x 99.36(V)
Pixels H x V		640x3(RGB) x 480
Pixel Pitch	mm	0.207 x 0.207
Pixel Arrangement		R.G.B. Vertical Stripe
Display Mode		TN, Normally White
Nominal Input Voltage VDD	Volt	3.3 typ.
Typical Power Consumption	Watt	3.86W (LCD:0.86W/LED BLU: 3.0W) All black pattern
Weight	Grams	170g (typ.)
Physical Size	mm	153.0(H)x 118.0(V) x 10.9(D) (typ.)
Electrical Interface		1 channel LVDS
Surface Treatment		Glare, AR, Hardness: 3H
Support Color		16.2M / 262K colors
The most suitable view angle		6 o'clock
Temperature Range Operating Storage (Non-Operating)	°C °C	-30 to +80* -30 to +80* *Panel surface temperature
RoHS Compliance		RoHS Compliance

## 2.2 Optical Characteristics

The optical characteristics are measured under stable conditions at 25°C (Room Temperature).

Item	Unit	Conditions	Min.	Typ.	Max.	Remark
White Luminance	cd/m <sup>2</sup>	F <sub>PWM</sub> = 100% (center point)	600	800	-	Note 1
Uniformity	%	5 Points		-	1.25	Note 1, 2, 3
Contrast Ratio			400	600	-	Note 4
Response Time	msec	Rising	-	15	20	Note 5
	msec	Falling	-	10	15	
	msec	Rising + Falling	-	25	35	
Viewing Angle	degree degree	Horizontal (Right) CR = 10 (Left)	70	80	-	Note 6
			70	80	-	
	degree degree	Vertical (Upper) CR = 10 (Lower)	60	70	-	
			60	70	-	
Color / Chromaticity Coordinates (CIE 1931)		White x	0.263	0.313	0.363	
		White y	0.279	0.329	0.379	
		Red x	0.559	0.609	0.659	
		Red y	0.314	0.364	0.414	
		Green x	0.285	0.335	0.385	
		Green y	0.554	0.604	0.654	
		Blue x	0.099	0.149	0.159	
		Blue y	0.055	0.105	0.155	
Color Gamut	%		50	55	-	

### Note 1: Measurement method

- Equipment      Pattern Generator, Power Supply, Digital Voltmeter, Luminance meter (SR\_3 or equivalent)
- Aperture        1□ with 50cm viewing distance
- Test Point      Center
- Environment    < 1 lux

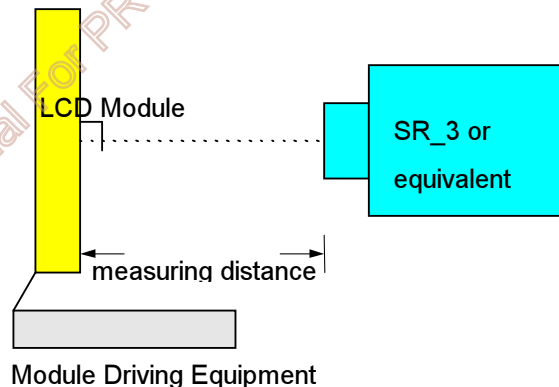

Note 2: Definition of 5 points position (Display active area: 132.48mm(W) x 99.36mm(H))

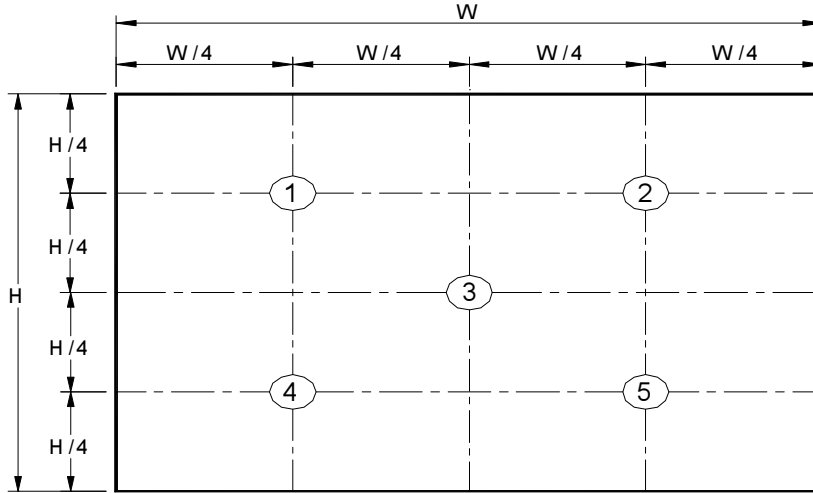

Note 3:

The luminance uniformity of 5 points is defined by dividing the maximum luminance value by the minimum luminance value at full white condition.

$$\delta_{w5} = \frac{\text{Maximum Brightness of five points}}{\text{Minimum Brightness of five points}}$$

Note 4: Definition of contrast ratio (CR):

$$\text{Contrast ratio (CR)} = \frac{\text{Brightness @ "White" state}}{\text{Brightness @ "Black" state}}$$

Note 5: Definition of response time:

The output signals of photo detector are measured when the input signals are changed from "White" to "Black" (falling time) and from "Black" to "White" (rising time), respectively. The response time interval definition is between 10% and 90% of amplitude. Please refer to the figure as below.

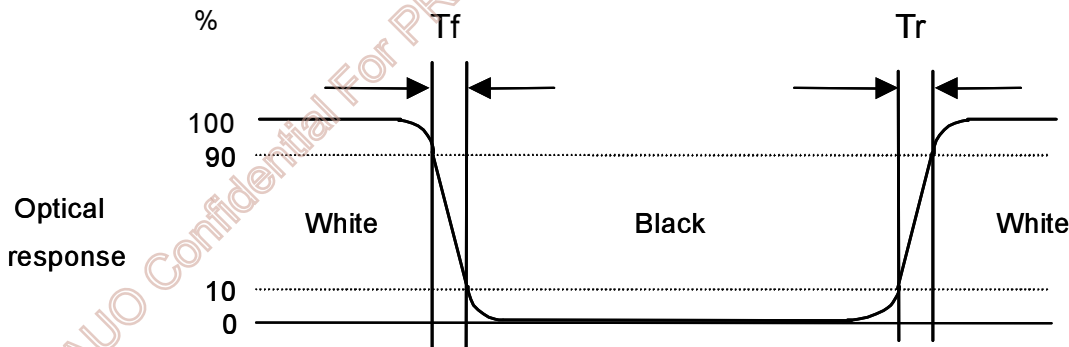

Note 6: Definition of viewing angle

Viewing angle is the measurement of contrast ratio  $\geq 10$ , at the screen center, over 180° horizontal and 180° vertical range. The 180° horizontal ( $\theta_L, \theta_R$ ) and 180° vertical ( $\phi_H, \phi_L$ ) range are illustrated as following figure.

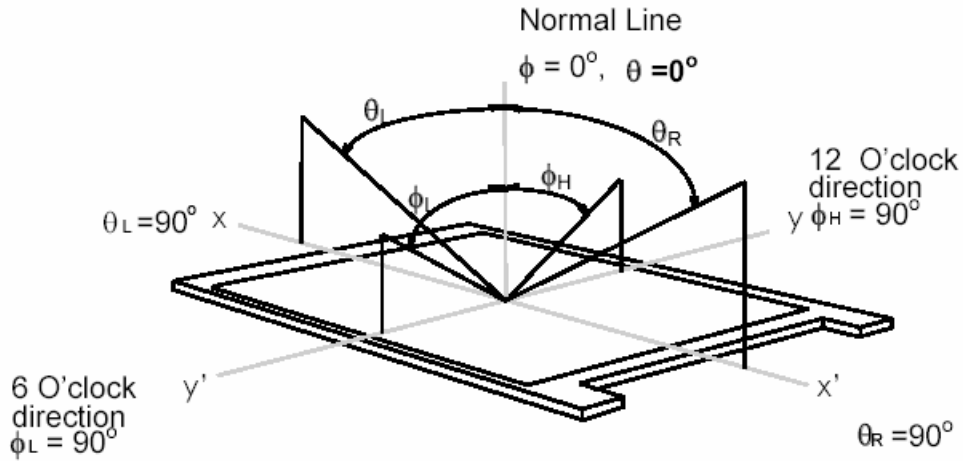

### 3. Functional Block Diagram

The following diagram shows the functional block of the G065VN01 V2 color TFT/LCD module.

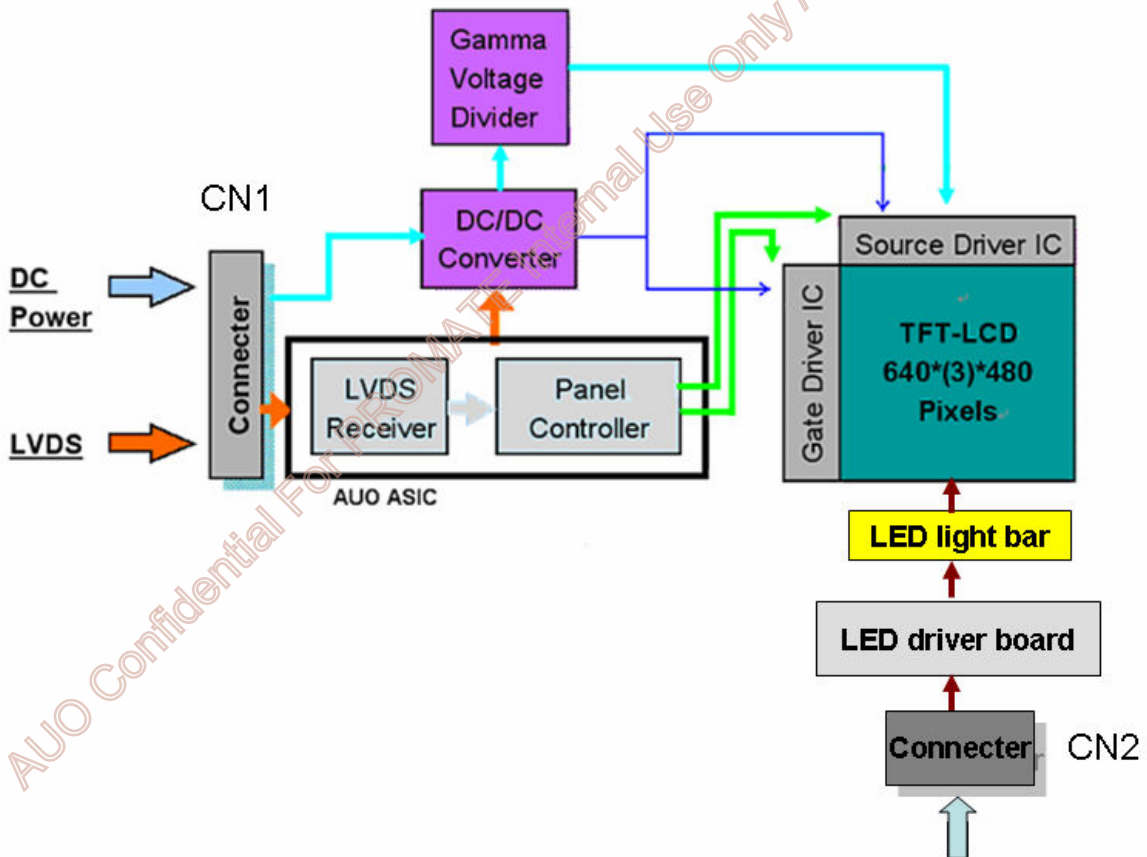



## 4. Absolute Maximum Ratings

### 4.1 Absolute Ratings

Item	Symbol	Min	Max	Unit	Remark
Logic/LCD Drive Voltage	VDD	-0.3	+4.0	Volt	Ta= 25°C
LCD Input Signal Voltage	VIN	-0.3	+4.0	Volt	Ta= 25°C
LED BLU Drive Voltage	V <sub>LED</sub>	0	25	Volt	Ta= 25°C
LED Dimming Input Voltage	V <sub>PWM</sub>	0	6	Volt	Ta= 25°C

### 4.2 Absolute Ratings of Environment

Item	Symbol	Min	Max	Unit	Remark
Operating Temperature	TOP	-30	+80*	°C	Note 1, 2
Operation Humidity	HOP	5	95	%RH	Note 1, 2
Storage Temperature	TST	-30	+80*	°C	Note 1
Storage Humidity	HST	5	95	%RH	Note 1

Note 1: Maximum Wet-Bulb should be 39° and no condensation.

Note 2: Only operation is guaranteed. Optical and display performance should be evaluated at 25° only.

\*: Panel surface temperature

AUO Confidential For PROMATE Internal Use Only / 2012/4/2

## 5. Electrical Characteristics

### 5.1 TFT-LCD Driving

#### 5.1.1 Power Specification

Symbol	Parameter	Min	Typ	Max	Units	Remark
VDD	Logic/LCD Drive Voltage	3.0	3.3	3.6	Volt	
IDD	VDD Current	-	260	300	mA	All Black Pattern (VDD=3.3V, at 60Hz)
Irush	LCD Inrush Current	-	-	1.5	A	Note 1
PDD	VDD Power	-	0.86		Watt	All Black Pattern (VDD=3.3V, at 60Hz)
VDDrp	Allowable Logic/LCD Drive Ripple Voltage	-	-	100	mVp-p	All Black Pattern (VDD=3.3V, at 60Hz)

Note 1: Measurement condition:

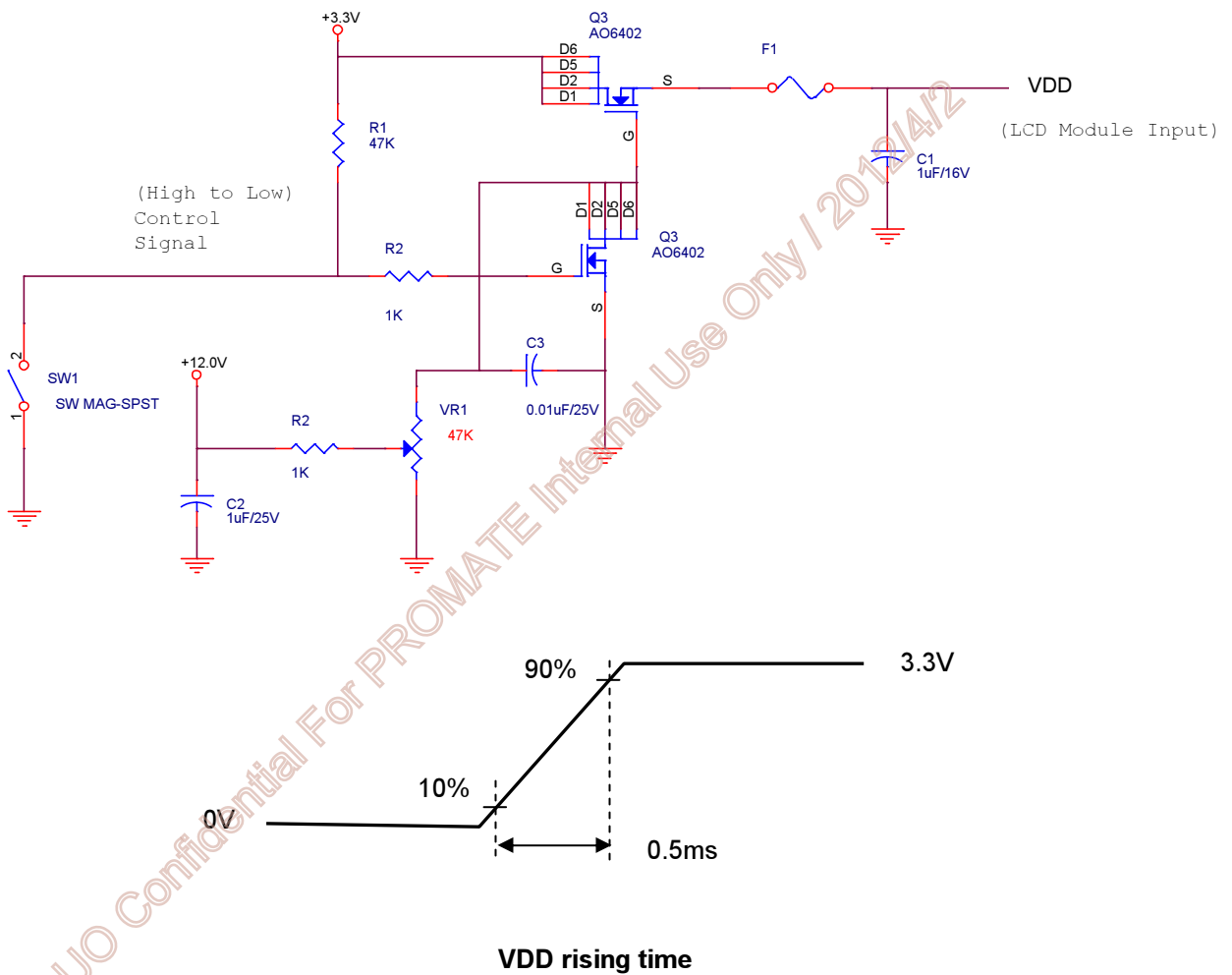

### 5.1.2 Signal Electrical Characteristics

Input signals shall be low or Hi-Z state when VDD is off.

#### LVDS signal (Note 1)

LVDS Transmitter: THC63LVDM83A (THINE) or equivalent

Parameter	Symbol	Min.	Typ.	Max.	Unit	Remark
Differential Input High Threshold	VTH	-	-	100	mV	VCM=1.20V
Differential Input Low Threshold	VTL	-100	-	-	mV	VCM=1.20V
Input Differential Voltage	VID	100	400	600	mV	
Differential Input Common Mode Voltage	VCM	1.1	-	1.45	V	VTH, VTL= ±100mV

Note 1: LVDS Signal Waveform.

#### Single-end Signal

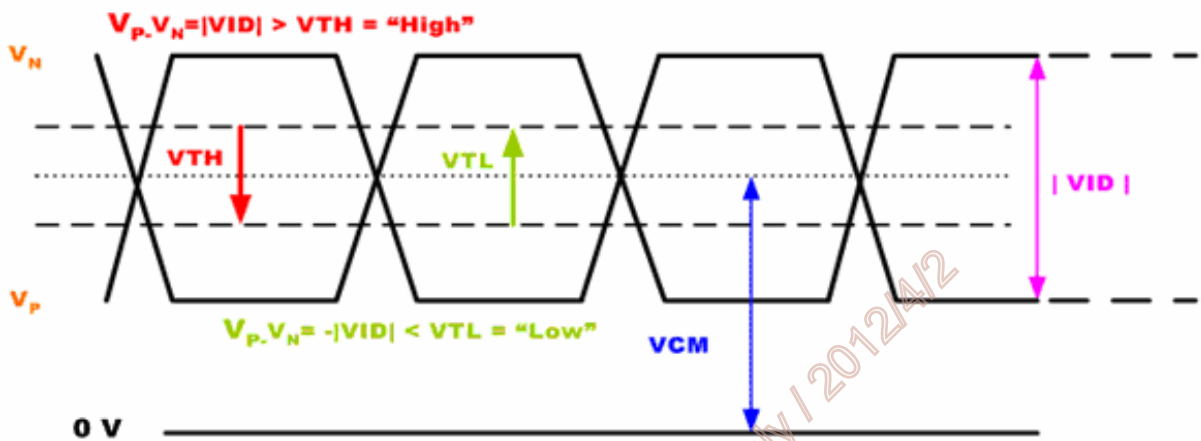

#### Differential Signal

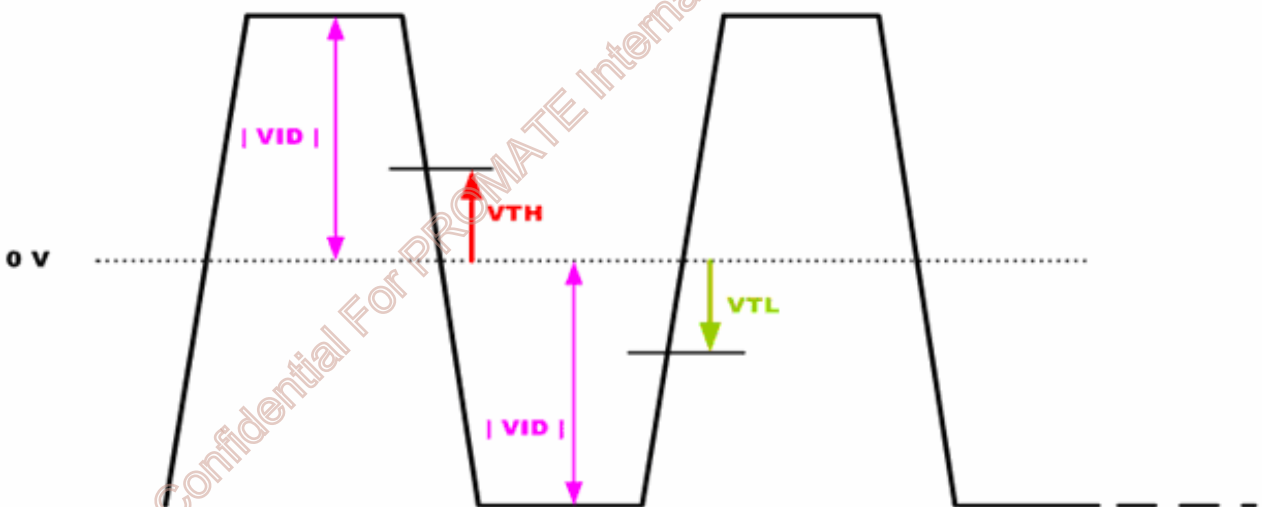

## 5.2 Backlight Unit Driving

### 5.2.1 Parameter guideline for LED driver

Following characteristics are measured under stable condition at 25°C (Room Temperature).

Symbol	Parameter	Min	Typ	Max	Units	Remark
$V_{LED}$	Input Voltage	9	12	20	Volt	
$I_{LED}$	Input Current	-	0.25		A	100% PWM duty
$P_{LED}$	Power Consumption	-	3.0		W	100% PWM duty
$I_{rushLED}$	Inrush Current	-	0.37	0.41	A	100% PWM duty
$V_{LED\ On/Off}$	On Control Voltage	3.0	3.3	5.0	Volt	
	Off Control Voltage	0		0.15	Volt	
$V_{PWM}$	Dimming control Voltage High	3.0	3.3	5.0	Volt	
	Dimming control Voltage Low	0		0.1	Volt	
$F_{PWM}$	Dimming Frequency	200		30K	Hz	
$D_{PWM}$	Dimming duty cycle	1		100	%	
Operating Life		50000			Hrs	Note 2, 3

Note 1: See Section 6.6 for LED Backlight Unit Interface Signal Description.

Note 2: If G065VN01 V2 module is driven at high ambient temperature & humidity condition. The operating life will be reduced.

Note 3: Operating life means brightness goes down to 50% initial brightness. Typical operating life time is estimated data.

AUO Confidential For PROMATE Internal Use Only | 2012/4/2

## 6. Signal Characteristic

### 6.1 Pixel Format Image

Following figure shows the relationship between input signal and LCD pixel format.

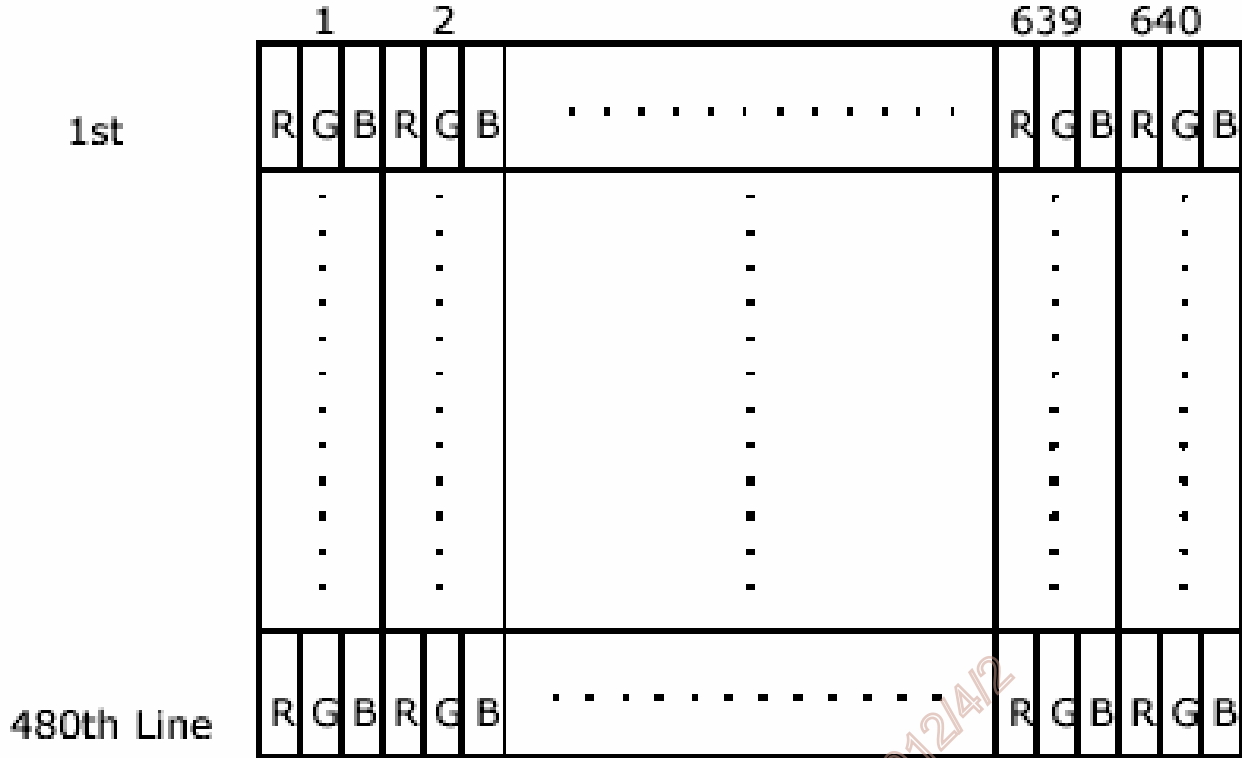

### 6.2 Scanning Direction

The following figures show the image seen from the front view. The arrow indicates the direction of scan.

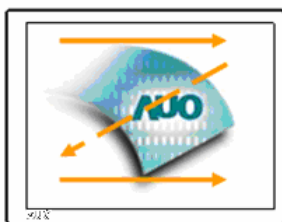

R/L=Low or NC; U/D= Low or NC



R/L=High; U/D= Low or NC

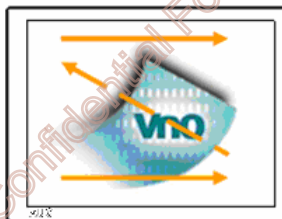

R/L=Low or NC; U/D= High

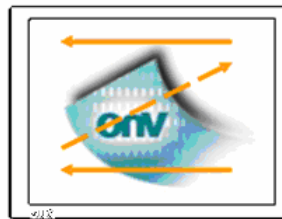

R/L=High; U/D= High

Note 1: TFT-LCD interface signal description is shown in section 6.4.

### 6.3 The Input Data Format

**SEL68 = "Low" or "NC" for 6 bits LVDS Input**

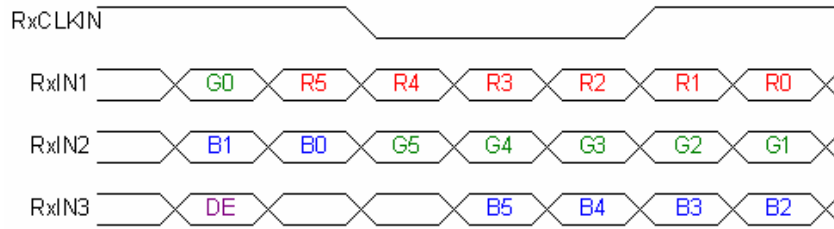

**SEL68 = "High" for 8 bits LVDS Input**

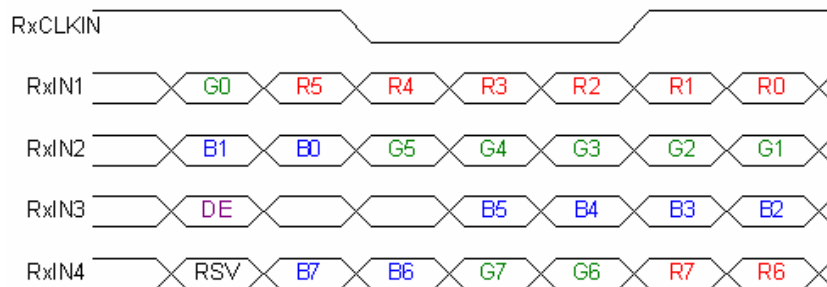

Signal Name	Description	Remark
R7	Red Data 7	Red-pixel Data  For 8Bits LVDS input MSB: R7 ; LSB: R0  For 6Bits LVDS input MSB: R5 ; LSB: R0
R6	Red Data 6	
R5	Red Data 5	
R4	Red Data 4	
R3	Red Data 3	
R2	Red Data 2	
R1	Red Data 1	
R0	Red Data 0	
G7	Green Data 7	Green-pixel Data  For 8Bits LVDS input MSB: G7 ; LSB: G0  For 6Bits LVDS input MSB: G5 ; LSB: G0
G6	Green Data 6	
G5	Green Data 5	
G4	Green Data 4	
G3	Green Data 3	
G2	Green Data 2	
G1	Green Data 1	
G0	Green Data 0	
B7	Blue Data 7	Blue-pixel Data  For 8Bits LVDS input MSB: B7 ; LSB: B0  For 6Bits LVDS input MSB: B5 ; LSB: B0
B6	Blue Data 6	
B5	Blue Data 5	
B4	Blue Data 4	
B3	Blue Data 3	
B2	Blue Data 2	
B1	Blue Data 1	
B0	Blue Data 0	
RxCLKIN	LVDS Data Clock	
DE	Data Enable Signal	When the signal is high, the pixel data shall be valid to be displayed.
RSV	Reserved Signal	"High" or "Low" is acceptable

Note 1: Output signals from any system shall be low or Hi-Z state when VDD is off.

## 6.4 TFT- LCD Interface Signal Description

G065VN01 V2 TFT-LCD module includes LVDS receiver. LVDS is a differential signal technology for high-speed data transfer LCD interface. LVDS Transmitter shall be THC63LVDM83A (THINE) or equivalent.

Pin No.	Symbol	Pin Description
1	VDD	Power supply, 3.3V (typical)
2	VDD	Power supply, 3.3V (typical)
3	GND	Ground
4	SEL68	Selection for either 6bit or 8bit LVDS input: SEL68 = "Low" or "NC", accepts 6bit LVDS data input; SEL68 = "High", accepts 8bit LVDS data input.
5	RxIN1-	Negative LVDS differential input (R0-R5, G0)
6	RxIN1+	Positive LVDS differential input (R0-R5, G0)
7	GND	Ground
8	RxIN2-	Negative LVDS differential input (G1-G5, B0-B1)
9	RxIN2+	Positive LVDS differential input (G1-G5, B0-B1)
10	GND	Ground
11	RxIN3-	Negative LVDS differential input (B2-B5, DE)
12	RxIN3+	Positive LVDS differential input (B2-B5, DE)
13	GND	Ground
14	RxCLKIN-	Negative LVDS differential clock input
15	RxCLKIN+	Positive LVDS differential clock input
16	NC	No connection
17	U/D	Vertical Reverse ("L" or NC: Normal, "H": Reverse)
18	R/L	Horizontal Reverse ("L" or NC: Normal, "H": Reverse)
19	RxIN4-	Negative LVDS differential input (R6-R7, G6-G7, B6-B7) NC for 6bit LVDS input.
20	RxIN4+	Positive LVDS differential input (R6-R7, G6-G7, B6-B7) NC for 6bit LVDS input.

Note 1: "Low" stands for 0V. "High" stands for 3.3V. "NC" stands for "No Connection".

## 6.5 TFT- LCD Interface Timing

### 6.5.1 Timing Characteristics

DE mode only

Signal		Symbol	Min.	Typ.	Max.	Unit	Remark
Clock frequency (DOTCLK)		$1/T_{\text{CLOCK}}$	20	25.2	50	MHz	Note1
Horizontal Section	Period	$T_H$	770	800	1070	$T_{\text{CLOCK}}$	Note1
	Active	$T_{\text{HD}}$	640				
	Blanking	$T_{\text{HB}}$	130	160	430		
Vertical Section	Period	$T_V$	520	525	622	$T_{\text{LINE}}$	Note1
	Active	$T_{\text{VD}}$	480				
	Blanking	$T_{\text{VB}}$	40	45	142		

Note 1: Recommended frame rate is 60 Hz.

### 6.5.2 Input Timing Diagram

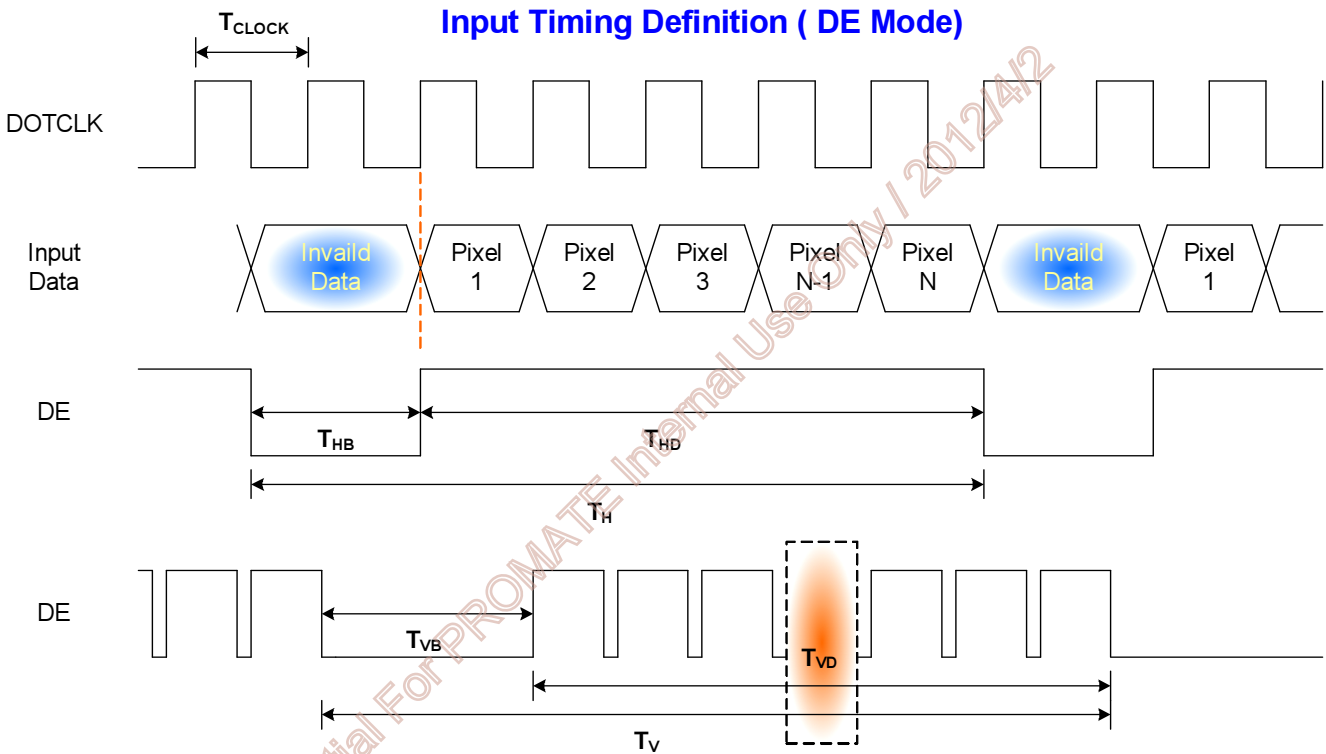



## 6.6 LED Backlight Unit Interface Signal Description

Pin #	Symbol	Pin Description
1	V <sub>LED</sub>	12V input
2	V <sub>LED</sub>	12V input
3	GND	Ground
4	GND	Ground
5	LED On/Off	3.3V-On; 0V/NC-Off
6	PWM DIM	1~100%

Note1: "NC stands for "No Connection".

AUO Confidential For PROMATE Internal Use Only / 2012/4/2

### 6.7 Power ON/OFF Sequence

VDD power, LCD interface signals and backlight on/off sequence are shown in the following chart. Signals from any system shall be Hi-Z state or low level when VDD is off.

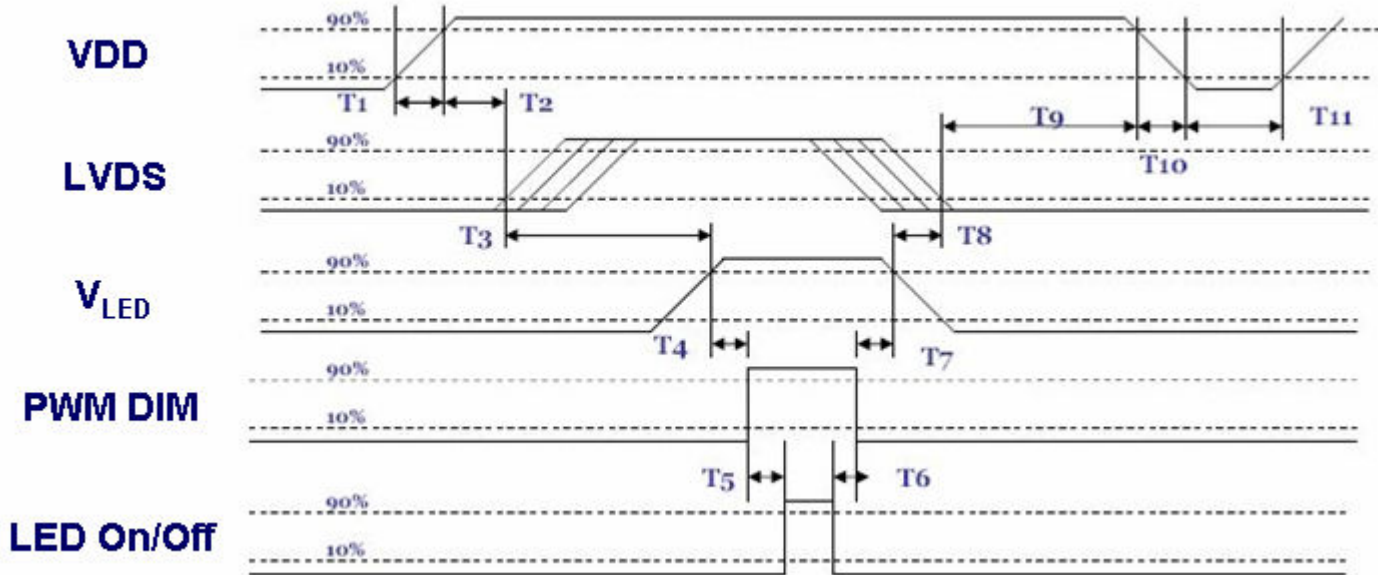

Power ON/OFF sequence timing

Parameter	Value			Units
	Min.	Typ.	Max.	
T1	0.5	-	10	ms
T2	30	40	50	ms
T3	200	-	-	ms
T4	10	-	-	ms
T5	10	-	-	ms
T6	0	-	-	ms
T7	10	-	-	ms
T8	100	-	-	ms
T9	0	16	50	ms
T10	-	-	10	ms
T11	1000	-	-	ms

ON/OFF sequence should be applied to avoid abnormal function in the display. Please make sure to turn off the power when you plug the cable into the input connector or pull the cable out of the connector.

## 7. Connector & Pin Assignment

### 7.1 TFT- LCD Signal (CN1): LCD Connector

<b>Manufacturer</b>	STM
<b>Connector Model Number</b>	MSB24013P20, compatible with I-PEX 20268-020E
<b>Mating Connector Model Number</b>	Hirose DF19 -20S-1C or compatible

Pin#	Symbol	Pin#	Symbol
1	VDD	11	RxIN3-
2	VDD	12	RxIN3+
3	GND	13	GND
4	SEL68	14	RxCLKIN-
5	RxIN1-	15	RxCLKIN+
6	RxIN1+	16	NC
7	GND	17	U/D
8	RxIN2-	18	R/L
9	RxIN2+	19	RxIN4-
10	GND	20	RxIN4+

### 7.2 LED Backlight Unit (CN2): Backlight Connector

<b>Manufacturer</b>	STM
<b>Connector Model Number</b>	MS24016RHD, compatible with MOLEX 53261-0671
<b>Mating Connector Model Number</b>	STM P24016 or compatible

Pin #	Symbol	Pin #	Symbol
1	V <sub>LED</sub>	4	GND
2	V <sub>LED</sub>	5	LED ON/OFF
3	GND	6	PWM DIM

## 7.3 PIN 1 definition of CN1 and CN2

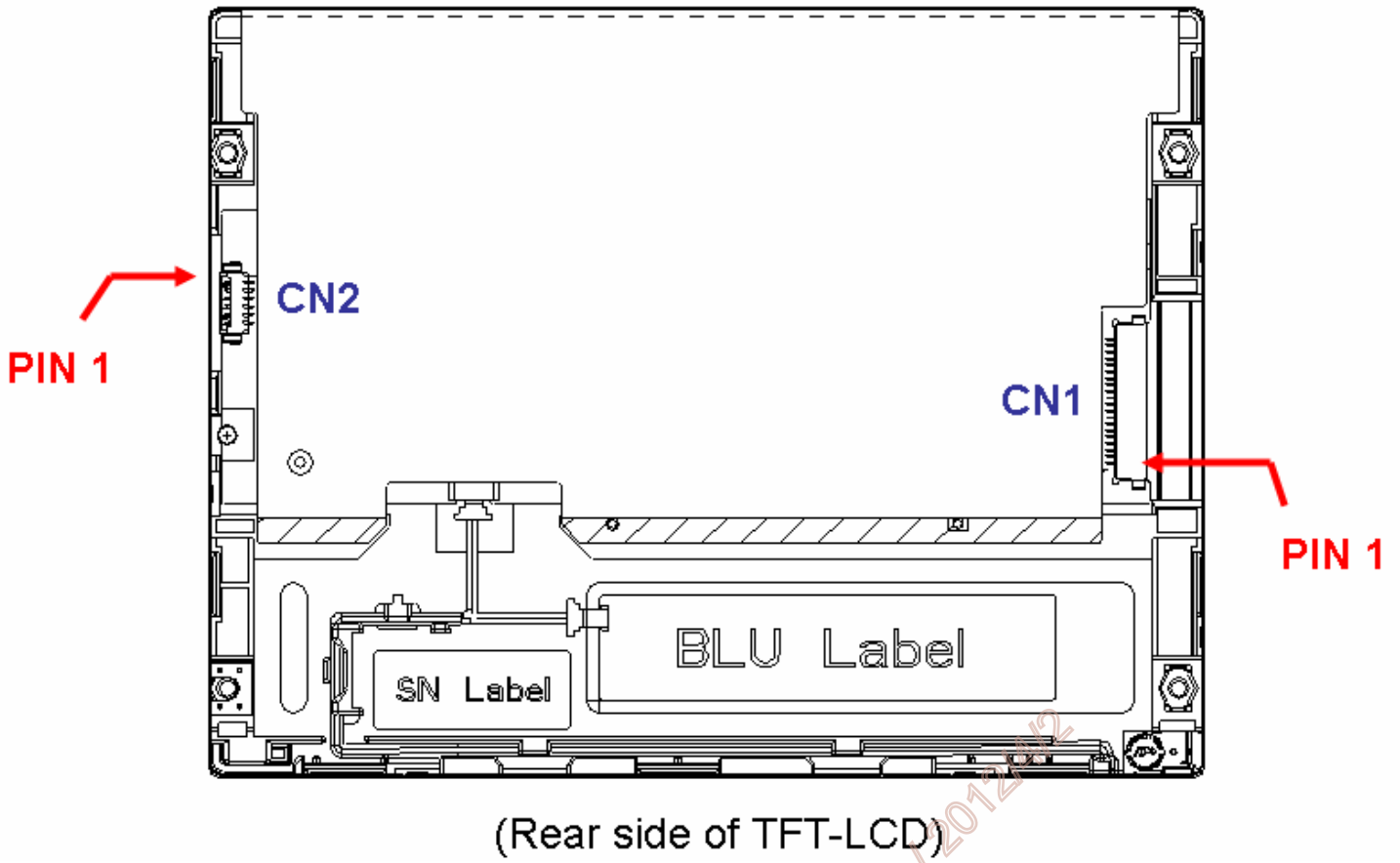

AUO Confidential For PROMATE Internal Use Only / 2012/02/12

## 8. Reliability Test Criteria

Items	Required Condition	Remark
Temperature Humidity Bias	40□/90%, 300Hr	Note 2
High Temperature Operation	80□*, 300Hr	Note 2
Low Temperature Operation	-30□, 300Hr	Note 2
High Temperature Storage	80□*, 300 hours	Note 2
Low Temperature Storage	-30°C, 300 hours	Note 2
Thermal Shock Test	-30°C/30 min, 80°C*/30 min, 100cycles	Note 2
Hot Start Test	80°C*/1 Hr (min.), power on/off per 5 minutes, repeat 5 times	Note 2
Cold Start Test	-30°C/1 Hr (min.), power on/off per 5 minutes, repeat 5 times	Note 2
Shock Test (Non-Operating)	50G,20ms,Half-sine wave, (±X, ±Y, ±Z)	Note 2
Vibration Test (Non-Operating)	1.5G, 10~200~10Hz, Sine wave, 30mins/axis, 3 direction (X, Y, Z)	Note 2
ESD	Contact Discharge: ±8KV, 150pF(330Ω) 1sec, 8 points, 25 times/point Air Discharge: ±15KV, 150pF(330Ω) 1sec, 8 points, 25 times/point	Note 1,2
Attitude Test	Operating: 14,000 ft, Ramp: 2000 ft/min, 8hrs Non-operating: 40,000 ft, Ramp: 2000 ft/min, 24hrs	Note 2

Note1: According to EN61000-4-2 ESD class B criteria, some performance degradation is allowed. TFT-LCD module is self-recoverable, no data lost and no hardware failures after test.

Note2:

- Water condensation is not allowed for each test items.
- Each test is done by new TFT-LCD module. Don't use the same TFT-LCD module repeatedly for reliability test.
- The reliability test is performed only to examine the TFT-LCD module capability.
- To inspect TFT-LCD module after reliability test, please store it at room temperature and room humidity for 24 hours at least in advance.

\*: Panel surface temperature

AUO Confidential For PROMATE Internal Use Only / 2012/4/2

## 9. Mechanical Characteristics

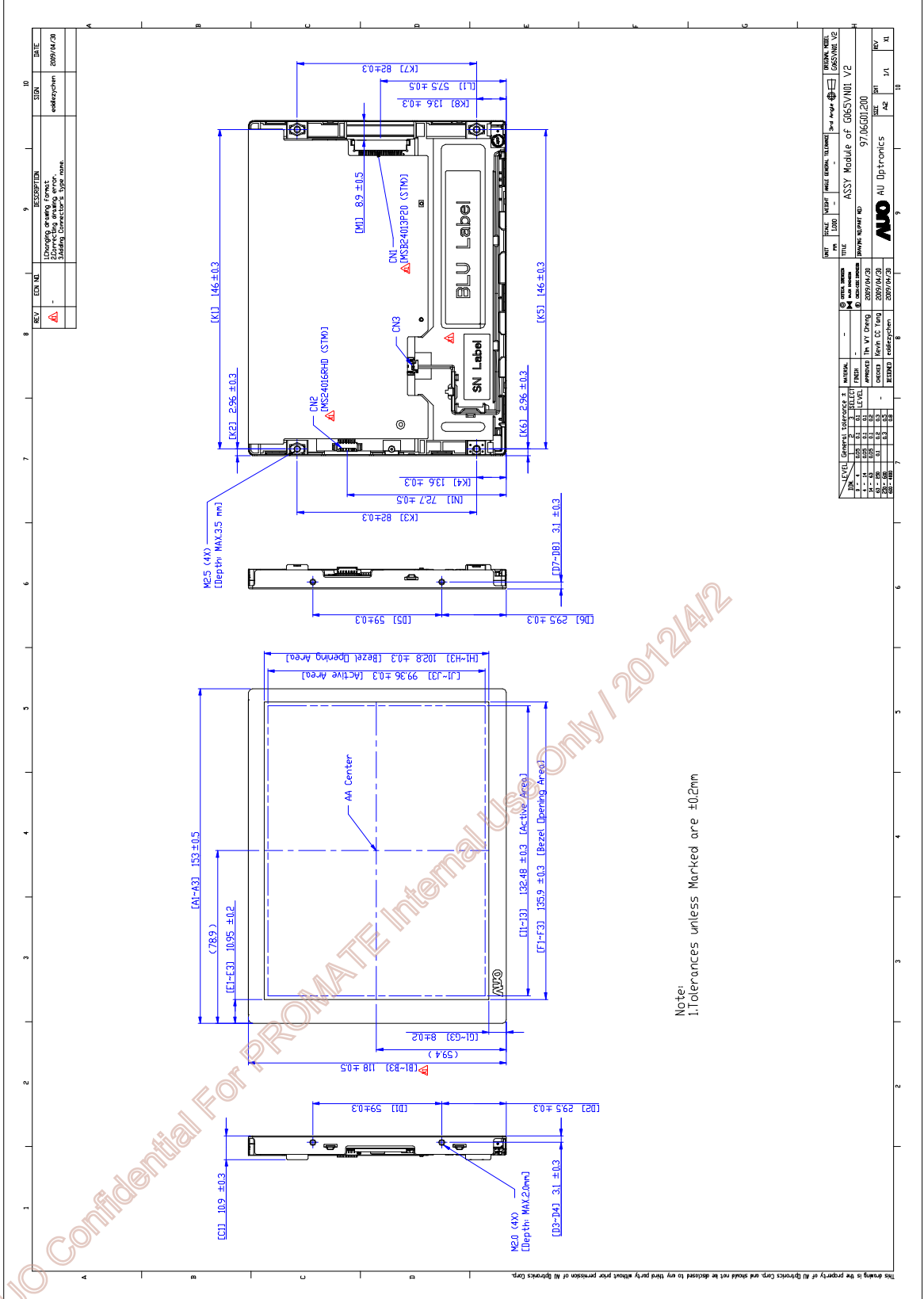

## 10. Label and Packaging

### 10.1 Shipping Label (on the rear side of TFT-LCD display)

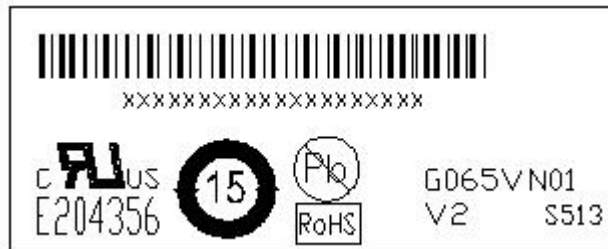

### 10.2 Carton Package

Max. capacity: 80 TFT-LCD module per carton (40pcs \* 2 layers)

Max. weight: 16.6 kg per carton

Outside dimension of carton: 425(L)mm\* 386(W)mm\* 430(H)mm

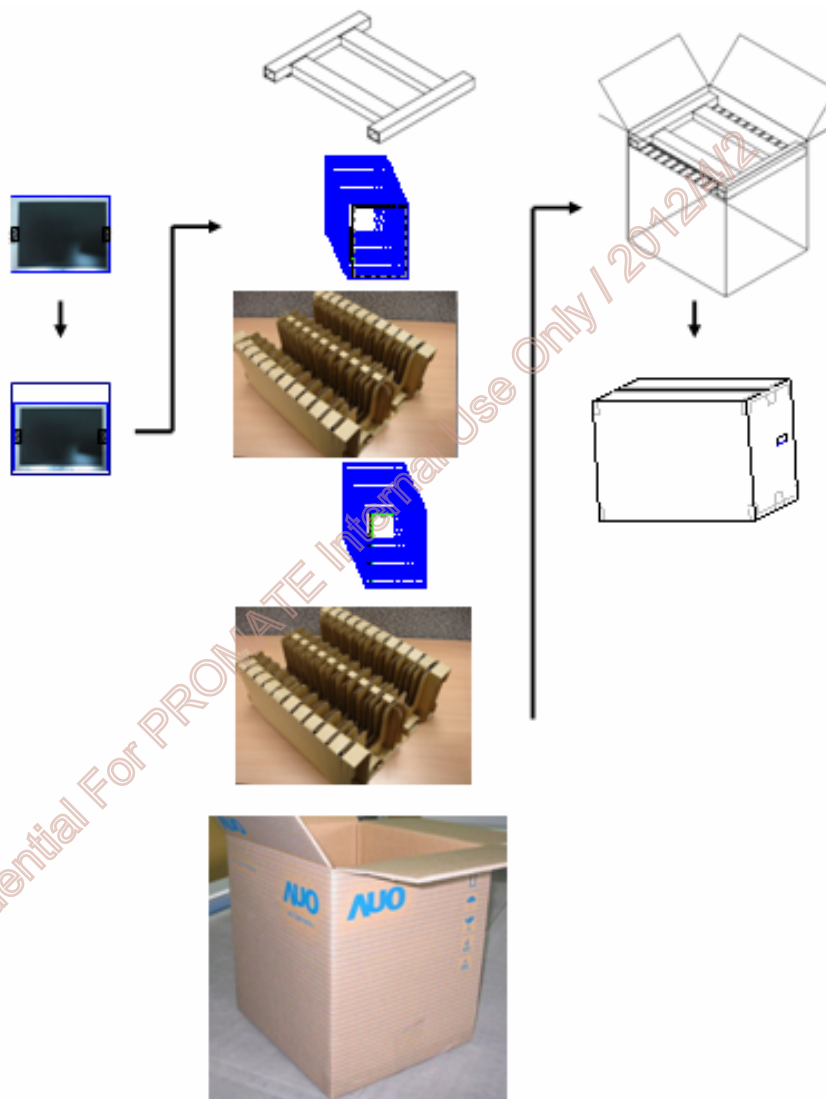

## 11 Safety

### 11.1 Keen Edge Requirements

There will be no keen edges or corners on the display assembly that could cause injury.

### 11.2 Materials

#### 11.2.1 Toxicity

There will be no carcinogenic materials used anywhere in the TFT-LCD module. If toxic materials are used, they will be reviewed and approved by the responsible AUO toxicologist.

#### 11.2.2 Flammability

All components including electrical components that do not meet the flammability grade UL94-V1 in the TFT-LCD Module will complete the flammability rating exception approval process.

The printed circuit board will be made from material rated 94-V1 or better. The actual UL flammability rating will be printed on the printed circuit board.

### 11.3 Capacitors

If any polarized capacitors are used in the TFT-LCD module, provisions will be made to keep them from being inserted backwards.

### 11.4 National Test Lab Requirement

The TFT-LCD Module will satisfy all requirements for compliance to UL 60950 (U.S.A. Information Technology Equipment).

AUO Confidential For PROMATE Internal Use Only / 2012/4/2



# Mouser Electronics

Authorized Distributor

Click to View Pricing, Inventory, Delivery & Lifecycle Information:

[Advantech:](#)

[96LEDK-A065VG80NA1](#)