

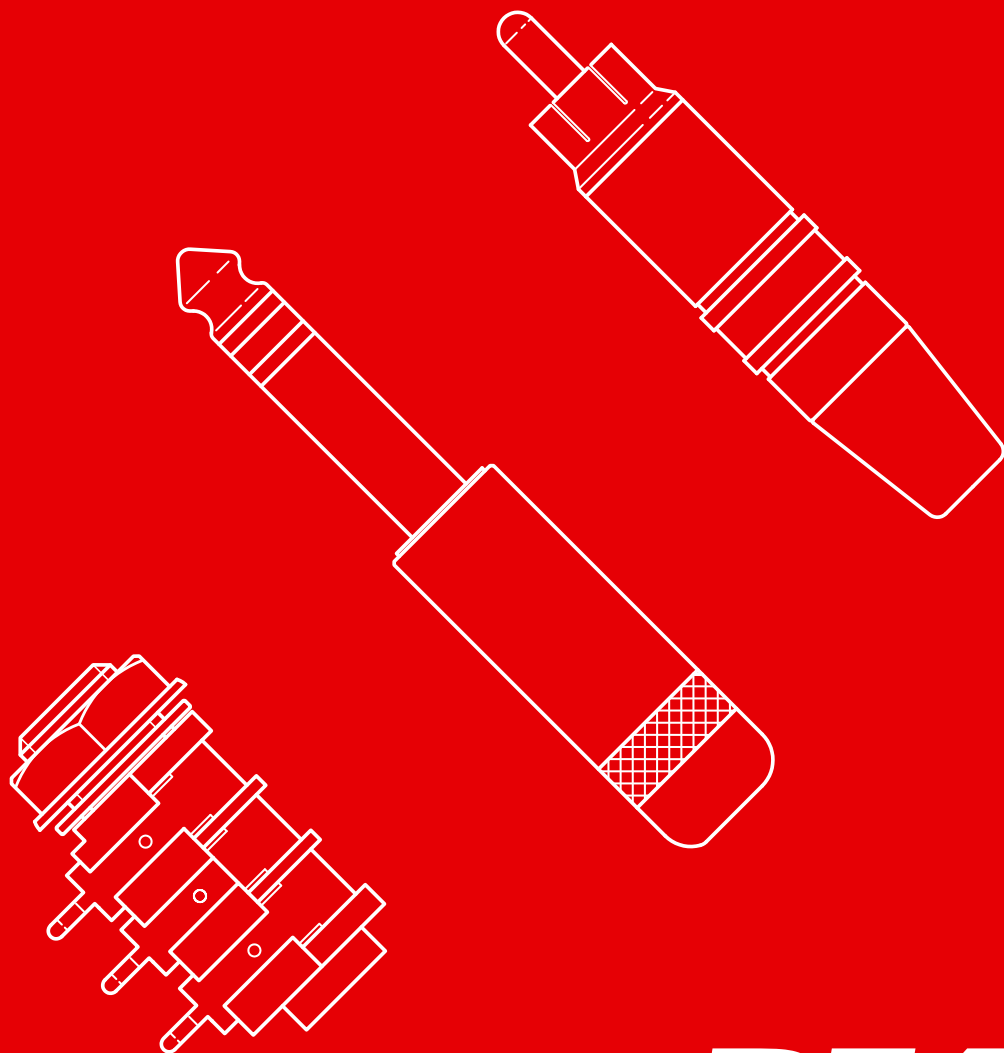

Product Guide | 2014/15





| Content | Page |
|---|------|
| TINY xlr Cable Connectors | 4 |
| TINY xlr Chassis Connectors and Adapters | 6 |
| 1/4" Vertical Jacks | 8 |
| 1/4" Phone Jacks | 10 |
| 1/4" Phone Plugs | 12 |
| 3.5 mm Phone Plugs, Cable Jacks and Adapter ... | 14 |
| Phono "RCA" | 16 |
| DIN Connectors | 18 |
| Patch Box & Stage Boxes | 20 |
| Dual Banana Plugs | 22 |

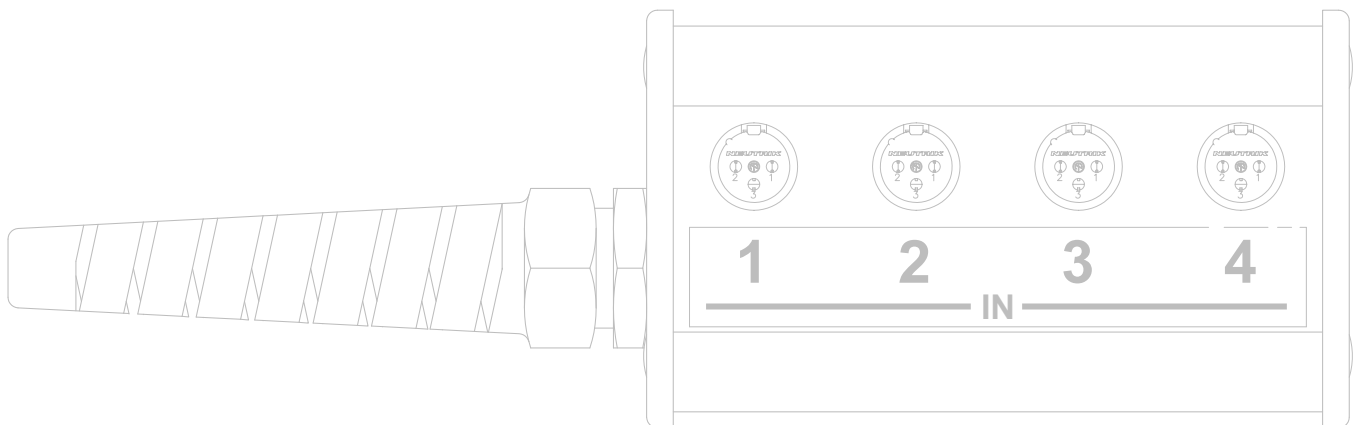

REAN®

With the brand REAN, the world's leading supplier of professional audio and video connectors – Neutrik AG – offers another interesting product range.

Excellent cost-performance ratio, attractive design and reliable functionality are the strengths of REAN.

Based on long-time know-how audio and video connectors for professional applications are developed and produced on up to date production facilities. An efficient logistics system and a global sales network make a high availability and short delivery times possible. The REAN product range is an alternative solution for cost sensitive applications.

REAN a brand of Neutrik AG

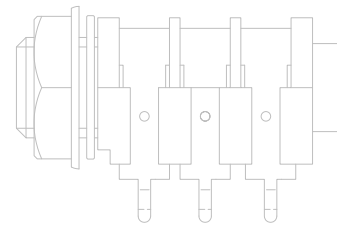
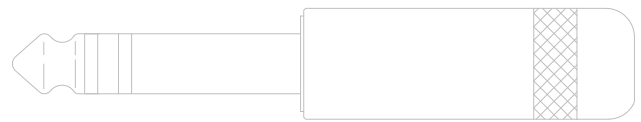
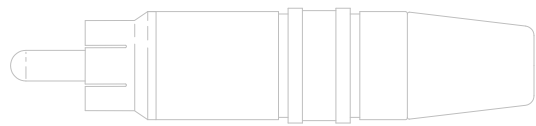



TINY xlr Cable Connectors



RT3FC-B



RT4FC-B-W



RT4FCT-B



RT3MC-B

- 3, 4 and 5 pole versions available
- Easy to assemble
- Robust metal housing with best flex relief
- Shielded system – high noise immunity and EMI protection
- Intuitive and rugged locking mechanism provides secure locking system
- Millionfold proven chuck type strain relief – up to 4.00 mm cable diameter

- Keyed insert and strain relief to avoid mispositioning/rotation of insert respectively cable
- RT*FC-B-W: optional sealing boot (patent pending) for water/sweat protection if mated with RT*MP
- RT*FCT-B: screw locking design for outstanding ruggedness – fits with common rear mountable connectors
- BRT-L: Accessory kit for cables from 4.00 – 5.00 mm

RT3FC-B

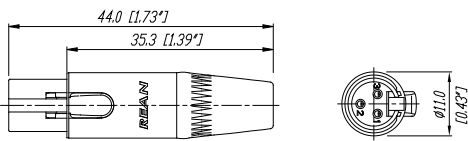

RT3FCT-B

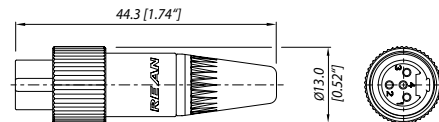

RT3FC-B-W

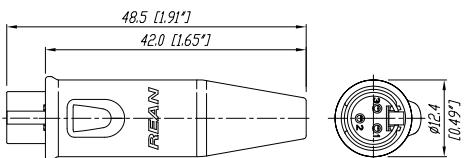

RT3MC-B

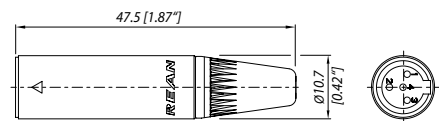

Female Pin-Layouts (front view)

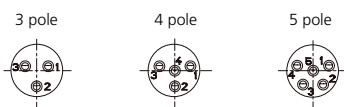

Male Pin-Layouts (front view)

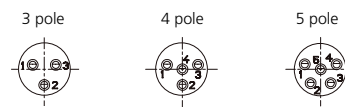

Ordering Information

| Type No. | Description | |
|--|-------------|--|
| Cable connectors | | |
| Female | Male | |
| RT3FC-B | RT3MC-B | 3 pole TINY cable connector, black metal shell, gold plated contacts |
| RT4FC-B | RT4MC-B | 4 pole TINY cable connector, black metal shell, gold plated contacts |
| RT5FC-B | RT5MC-B | 5 pole TINY cable connector, black metal shell, gold plated contacts |
| RT*FC-B-D | RT*MC-B-D | TINY cable connector, black metal shell, gold plated contacts; bulk packed, to be ordered in multiples of 100 pcs. |
| Cable connectors female water resistant | | |
| RT3FC-B-W | | 3 pole TINY female cable connector, black metal shell, water resistant boot, gold plated contacts |
| RT4FC-B-W | | 4 pole TINY female cable connector, black metal shell, water resistant boot, gold plated contacts |
| RT5FC-B-W | | 5 pole TINY female cable connector, black metal shell, water resistant boot, gold plated contacts |
| RT*FC-B-W-D | | TINY female cable connector, black metal shell, water resistant boot, gold plated contacts; bulk packed, to be ordered in multiples of 100 pcs. |
| Cable connectors female screw locking | | |
| RT3FCT-B | | 3 pole TINY female cable connector with screw locking, black metal shell & nut, gold plated contacts |
| RT4FCT-B | | 4 pole TINY female cable connector with screw locking, black metal shell & nut, gold plated contacts |
| RT5FCT-B | | 5 pole TINY female cable connector with screw locking, black metal shell & nut, gold plated contacts |
| RT*FCT-B-D | | TINY female cable connector with screw locking, black metal shell & nut, gold plated contacts; bulk packed, to be ordered in multiples of 100 pcs. |
| Accessories | | |
| BRT-L | | Bushing and chuck for cable diameters 4.0 – 5.0 mm |

Specification

Cable connectors
RT*FC-B*/RT*MC-B*

Screw locking
RT*FCT-B*

| Electrical | Cable connectors RT*FC-B*/RT*MC-B* | Screw locking RT*FCT-B* |
|---------------------------|---------------------------------------|-------------------------------|
| Rated current per contact | < 5 A | < 5 A |
| Contact resistance | < 10 mΩ | < 10 mΩ |
| Insulation resistance | > 1 GΩ | > 1 GΩ |
| Dielectric strength | > 500 V rms | > 500 V rms |
| Mechanical | | |
| Lifetime | > 5'000 mating cycles | > 5'000 mating cycles |
| Cable O.D. range | 2.0 – 4.0 mm | 2.0 – 4.0 mm |
| Wiring | solder contacts | solder contacts |
| Max. wire size | 0.22 mm ² / 24 AWG | 0.22 mm ² / 24 AWG |
| Material | | |
| Bushing | ABS | ABS |
| Contacts | female CuSn6 / male CuZn39Pb3 | CuSn6 |
| Contact plating | Au plated | Au plated |
| Insert | PA 6 30% GR | PA 6 30% GR |
| Shell (housing) | ZnAl4Cu1 | ZnAl4Cu1 |
| Shell plating | black | black |
| Strain relief | PVC | PVC |
| Protection boot | EPDM | – |
| Locking nut | – | Al, black anodized |
| Environment | | |
| Operating temperature | -30°C to +85°C | -30°C to +85°C |
| Solderability | complies with IEC68-2-20 | complies with IEC68-2-20 |



TINY xlr Chassis Connectors



RT3MP



RT4MPR

- Front and rear mountable receptacles in 3, 4 and 5 pole design
- Watertight chassis connector, even in unmated condition
- RT*MP provides water resistant connection if mated with RT*FC-B-W

TINY xlr Adapters



RA3FT-B



RA3MT-B

- Easy and fast solution to interconnect mini XLRs
- Rugged metal housing
- Mini XLR 3 pin to XLR-Male or XLR-Female

RT3MP

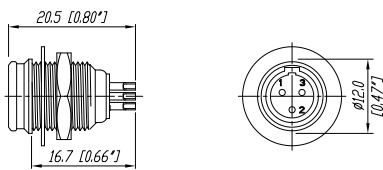

Panel Cutout

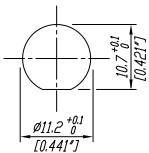

Male Pin-Layouts (front view)

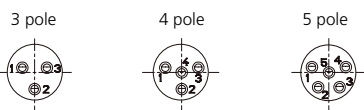

RA3FT-B

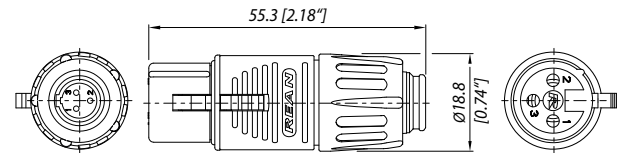

RA3MT-B

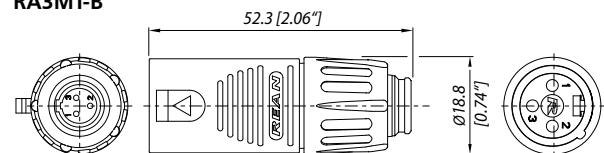

Ordering Information

| Type No. | Description |
|---|--|
| Chassis connectors | |
| RT3MP | 3 pole TINY male chassis connector, nickel metal housing, gold plated contacts, max. panel thickness: 6 mm |
| RT4MP | 4 pole TINY male chassis connector, nickel metal housing, gold plated contacts, max. panel thickness: 6 mm |
| RT5MP | 5 pole TINY male chassis connector, nickel metal housing, gold plated contacts, max. panel thickness: 6 mm |
| RT*MP-D | TINY male chassis connector, nickel metal housing, gold plated contacts, max. panel thickness: 6 mm; bulk packed, to be ordered in multiples of 100 pcs. |
| Chassis connectors rearmountable | |
| RT3MPR | 3 pole TINY rearmountable, male chassis connector, nickel metal housing, gold plated contacts, max. panel thickness: 3 mm |
| RT4MPR | 4 pole TINY rearmountable, male chassis connector, nickel metal housing, gold plated contacts, max. panel thickness: 3 mm |
| RT5MPR | 5 pole TINY rearmountable, male chassis connector, nickel metal housing, gold plated contacts, max. panel thickness: 3 mm |
| RT*MPR-D | TINY rearmountable male chassis connector, nickel metal housing, gold plated contacts, max. panel thickness: 3 mm; bulk packed, to be ordered in multiples of 100 pcs. |
| Adapters | |
| RA3FT-B | 3 pole adapter TINY male to female XLR, black metall shell, gold plated contacts |
| RA3MT-B | 3 pole adapter TINY male to male XLR, black metall shell, gold plated contacts |

Specification

| | Chassis connectors RT*MP* | Adapters RA*T-B |
|---------------------------|-------------------------------|-------------------------------|
| Electrical | | |
| Rated current per contact | < 5 A | – |
| Contact resistance | < 10 mΩ | ≤ 5 mΩ |
| Insulation resistance | > 1 GΩ | > 1 GΩ |
| Dielectric strength | > 500 V rms | 500 V rms |
| Mechanical | | |
| Lifetime | > 5'000 mating cycles | > 5'000 mating cycles |
| Wiring | solder contacts | – |
| Max. wire size | 0.22 mm ² / 24 AWG | – |
| Material | | |
| Contacts | CuZn39Pb3 | female CuSn6 / male CuZn39Pb3 |
| Contact plating | Au plated | Au plated |
| Insert | PA 6.6 30% GR | PA 6 30% GR |
| Shell (housing) | ZnAl4Cu1 | ZnAl4Cu1 |
| Shell plating | nickel | black |
| Environment | | |
| Operating temperature | -30°C to +85°C | -20°C to +65°C |
| Solderability | complies with IEC68-2-20 | – |

Jacks



1 / 4 " Vertical Jacks



RJ3VM



RJ5VM



RJ3VI-D1



RJ5VI-D1

- Vertical PCB-mount – Fit's widely used PCB layout of existing vertical jacks
- Space saving 1/4" jack – enables highest packing density
- Circumferential contact arrangement – provides reliable switching function
- Integrated body stop for the inserted 1/4" plug – ensures best conductivity independent from mating tip shape
- Spring loaded ground contact – maintains superior contact integrity

RJ3VM

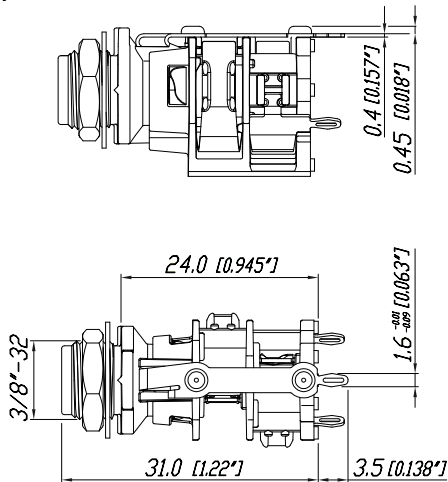

RJ5VM

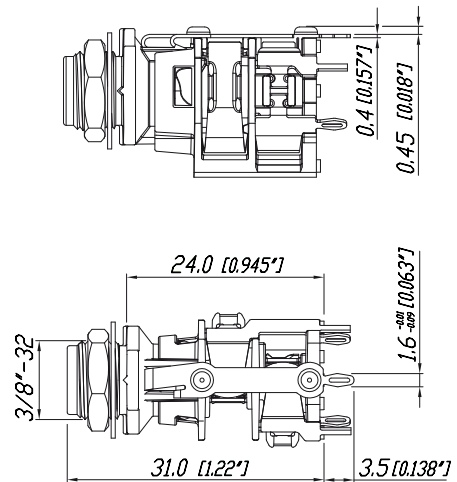

Ordering Information

| Type No. | Description |
|--|---|
| 1/4" Vertical Jack (bulk packed, to be ordered in multiples of 100 pcs.) | |
| RJ3VM | 1/4" TRS Jack, vertical PCB, metal nose, with nut and washer, no normalling contacts |
| RJ5VM | 1/4" TRS Jack, vertical PCB, metal nose, with nut and washer, with tip and ring normalling contacts |
| RJ3VM-D1 | 1/4" TRS Jack, vertical PCB D1, metal nose, with nut and washer, no normalling contacts |
| RJ5VM-D1 | 1/4" TRS Jack, vertical PCB D1, metal nose, with nut and washer, with tip and ring normalling contacts |
| RJ3VM-S | 1/4" TRS Jack, with solder lugs, metal nose, with nut and washer, no normalling contacts |
| RJ5VM-S | 1/4" TRS Jack, with solder lugs, metal nose, with nut and washer, with tip and ring normalling contacts |
| RJ3VI | 1/4" TRS Jack, vertical PCB, plastic nose, with nut and washer, no normalling contacts |
| RJ5VI | 1/4" TRS Jack, vertical PCB, plastic nose, with nut and washer, with tip and ring normalling contacts |
| RJ3VI-D1 | 1/4" TRS Jack, vertical PCB D1, plastic nose, with nut and washer, no normalling contacts |
| RJ5VI-D1 | 1/4" TRS Jack, vertical PCB D1, plastic nose, with nut and washer, with tip and ring normalling contacts |
| RJ3VI-S | 1/4" TRS Jack, with solder lugs, plastic nose, with nut and washer, no normalling contacts |
| RJ5VI-S | 1/4" TRS Jack, with solder lugs, plastic nose, with nut and washer, with tip and ring normalling contacts |

Ordering Key

W/o SUFFIX:



"-D1":



"-S":



Specification

Electrical

| | |
|---------------------------|----------|
| Rated current per contact | 3 A |
| Contact resistance | < 10 mΩ |
| Insulation resistance | ≥ 1 GΩ |
| Dielectric strength | 500 V dc |

Mechanical

| | |
|------------------------------|-----------------------|
| Lifetime | > 1'000 mating cycles |
| Insertion / withdrawal force | ≤ 20 N / ≥ 10 N |

Material

| | |
|-----------------|------------|
| Contacts | CuSn6 |
| Contact plating | Ag |
| Shell (housing) | PA6 30% GR |
| Thread nose | ZnAl4Cu1 |

Environment

| | |
|-----------------------|--------------------------|
| Operating temperature | -20°C to +70°C |
| Solderability | complies with IEC68-2-20 |

Jacks



1/4" Phone Jacks



NYS 216
Horizontal Jack



NYS 2202
Long Bushing



NYS 230
Open Jack

- Robust and reliable jacks in metal or plastic housing
- Horizontal and vertical PCB-mount
- Extra long-threaded bushing for thick panel and guitar bodies
- Plastic nut or chrome ferrule nut
- Kinked solder pins secure jack to PCB

NYS 220

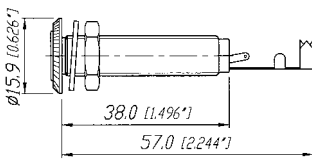

NYS 221

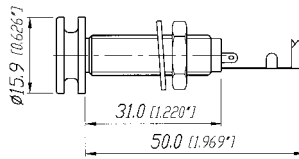

NYS 2162

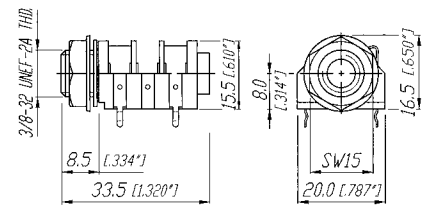

NYS 230

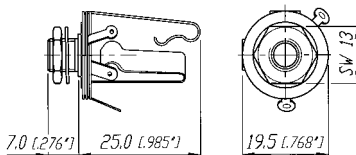

NYS 232

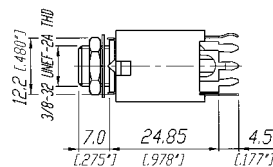

Ordering Information

| Type No. | Mono 2 pole | Stereo 3 pole | Description | Distance to PCB |
|--|-------------|---------------|---|-----------------|
| 1/4" long bushing jacks | | | | |
| NYS 2202 | • | | Jack for thick panels, long-threaded bushing with washer and nut, full metal | – |
| NYS 2203 | | • | Jack for thick panels, long-threaded bushing with washer and nut, full metal | – |
| NYS 221 | | • | Jack with special design head for guitar strap, for thick panels, long-threaded bushing with washer and nut, full metal | – |
| 1/4" horizontal jacks (all contacts switched) | | | | |
| NYS 212 | | • | Plastic housing with washer and nut, solder tap version | – |
| NYS 2122 | • | | Plastic housing with washer and nut, solder tap version | – |
| NYS 215 | | • | With chrome ferrule nut | 8.2 mm |
| NYS 2152 | • | | With chrome ferrule nut | 8.2 mm |
| NYS 2152G | • | | With chrome ferrule nut and gold contacts | 8.2 mm |
| NYS2152G-DHU | • | | Solder tap version with chrome ferrule nut, gold contacts, bulk packaging | – |
| NYS 216 | | • | Plastic housing with washer and nut | 8.2 mm |
| NYS 216H | | • | Plastic housing with washer and nut, half threaded nose | 8.2 mm |
| NYS 2162 | • | | Plastic housing with washer and nut | 8.2 mm |
| NYS 2162H | • | | Plastic housing with washer and nut, half threaded nose | 8.2 mm |
| NYS 216G | | • | With gold contact | 8.2 mm |
| NYS 218 | | • | With extra long contacts | 15.0 mm |
| NYS 2182 | • | | With extra long contacts | 15.0 mm |
| NYS 219 | | • | With long contacts | 12.5 mm |
| NYS 2192 | • | | With long contacts | 12.5 mm |
| 1/4" open jacks | | | | |
| NYS 229 | • | | 2 contacts, with washer and nut, panel thickness 3.5 mm | – |
| NYS 229L | • | | 2 contacts, with longer threaded nose, washer and nut, panel thickness 6.5 mm, with 0.205" faston tabs | – |
| NYS 230 | | • | 3 contacts, with washer and nut, panel thickness 3.5 mm | – |
| 1/4" vertical jacks | | | | |
| NYS 232 | | • | Plastic housing, metal washer and nut, with tip and ring normalling contacts | 24.85 mm |

Specification

Phone jacks

Electrical

| | |
|-----------------------|-----------------------------|
| Rated current | depends on mating connector |
| Contact resistance | depends on mating connector |
| Insulation resistance | ≥ 1 GΩ |
| Dielectric strength | 500 V dc |

Mechanical

| | |
|----------------------------|--------------------------|
| Lifetime | > 1'000 mating cycles |
| Insertion/withdrawal force | ≤ 20 N / ≥ 10 N |
| Solderability | complies with IEC68-2-20 |
| Operating temperature | -20°C to +70°C |

Material

| | |
|----------------|--------------------------|
| Housing/handle | Brass Ni / Thermoplastic |
| Insulation | Thermoplastic |
| Contacts | Brass, SnCe / Au plated |

Plugs

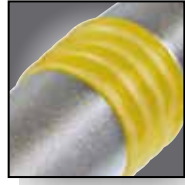

1/4" Phone Plugs



NYS 204



NYS 208



NYS 224G



NYS 224C-6

- Commercial 1/4" plugs and adapters
- All connectors according to EIA RS-453 / IEC 60603-11
- Short and long metal handles
- Plastic handle with flexible strain relief
- Heavy duty cable clamp for best strain relief

- Available with nickel, gold and black plating
- Large cable outlet and solder tabs
- Right angle version
- "Silent switch" on plug finger helps eliminate "pop" during insertion and withdrawal

NYS 201

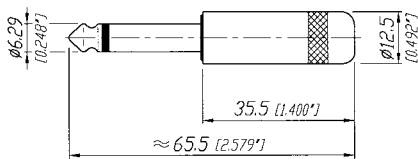

NYS 204

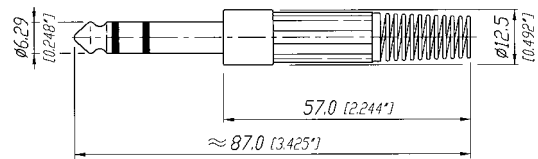

NYS 224

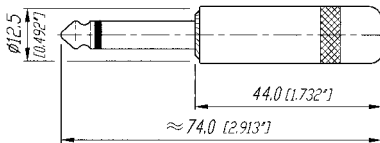

NYS 225

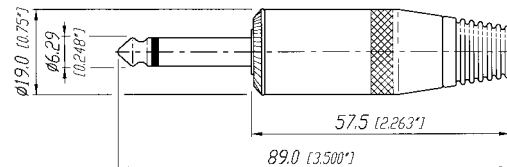

Part number coding: B black handle G gold plated contacts AG all gold, gold plated contacts and shell
 BG ... black handle, gold plated contacts S silent switch GT gold plated tip contact

Ordering Information

| Type No. | Mono 2 pole | Stereo 3 pole | Description | Cable O.D. |
|--|-------------|---------------|---|------------|
| 1/4" plugs short handle | | | | |
| NYS 201 | • | | Short turned metal handle | 6 mm |
| NYS 202 | | • | Short turned metal handle | 6 mm |
| 1/4" plugs plastic handle | | | | |
| NYS 203 | • | | Plastic handle with flexible strain relief | 6 mm |
| NYS 204 | | • | Plastic handle with flexible strain relief | 6 mm |
| 1/4" plugs right angle | | | | |
| NYS 207 | • | | Metal housing, plastic bushing | 6 mm |
| NYS 207-2 | • | | Metal housing, red cover & plastic bushing | 6 mm |
| NYS 208 | | • | Metal housing, plastic bushing | 6 mm |
| 1/4" plugs long handle | | | | |
| NYS 224 | • | | Long polished diecast handle, no rivet | 6 mm |
| NYS 224AG | • | | With gold plated handle and contacts | 6 mm |
| NYS 224BG | • | | With black metal handle, gold plated contacts | 6 mm |
| NYS 224G | • | | With gold plated contacts | 6 mm |
| NYS 224GT | • | | With gold plated tip contact | 6 mm |
| NYS 224L | • | | With large cable outlet | 8 mm |
| NYS 224S | • | | With tip switched to ground if not inserted (silent) | 6 mm |
| NYS 224C-* | • | | Diecast handle with coloured coding ring & rubber flex relief | 6 mm |
| NYS 228 | | • | Stereo version of NYS 224 | 6 mm |
| NYS 228BG | | • | With black metal handle, gold plated contacts | 6 mm |
| NYS 228G | | • | With gold plated contacts | 6 mm |
| NYS 228GT | | • | With gold plated tip contact | 6 mm |
| *) 0 - black, 2 - red, 4 - yellow, 5 - green, 6 - blue | | | | |
| 1/4" plugs with large shell for speaker cables | | | | |
| NYS 225 | • | | Large metal handle, rubber bushing | 8 mm |
| NYS 225B | • | | With black metal handle | 8 mm |
| NYS 225L | • | | With large cable outlet | 9 mm |
| NYS 225S | • | | With tip switched to ground if not inserted (silent) | 8 mm |

Specification

Phone
plugs

| Electrical | |
|--------------------------------------|--|
| Rated current and contact resistance | depends on mating connector |
| Insulation resistance | ≥ 1 GΩ |
| Dielectric strength | 500 V dc |
| Mechanical | |
| Lifetime | 1'000 mating cycles |
| Solderability | complies with IEC68-2-20 |
| Operating temperature | -20°C to +70°C |
| Material | |
| Housing/handle | Zinc Diecast, Ni / Au / black plated |
| Insulation | • (NYS 203 / 204 ABS) Thermoplastic |
| Contacts | Brass, Ni / Au plated |
| Strain relief | Crimp type SnCe plated |

Plugs

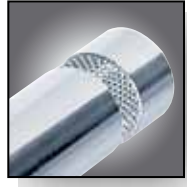

3.5 mm Phone Plugs

Cable Jacks & Adapters



NYS 226



NYS 231BG



NYS 2202P
Cable jack



NYS 240
Cable jack



NYS 236
Phone jack adapter

- Commercial 3.5 mm plugs
- All connectors according to EIA RS-453 / IEC 60603-11
- Heavy duty cable clamp for best strain relief
- Available with nickel and black plating
- Large cable outlet available

- Robust and reliable jacks (1/4" and 3.5 mm) in metal housing
- Heavy duty cable clamp
- Available with nickel and black plating
- 1/4" adapters to interconnect mono & stereo lines

NYS 231

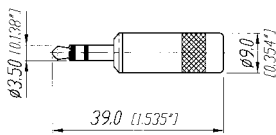

NYS 2202P

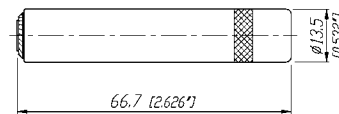

NYS 237

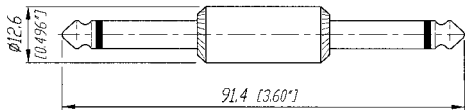

NYS 240

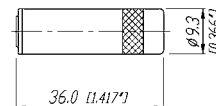

Ordering Information

| Type No. | Mono 2 pole | Stereo 3 pole | Description | Cable O.D. |
|--------------------------------------|-------------|---------------|---|------------|
| 1/4" plug & jack adapters | | | | |
| NYS 237 | • | | Mono plug adapter to mate standard 1/4" jacks, full metal | – |
| NYS 239 | | • | Stereo plug adapter to mate standard 1/4" jacks, full metal | – |
| NYS 236 | • | | Mono jack adapter to mate standard 1/4" plugs, full metal | – |
| NYS 238 | | • | Stereo jack adapter to mate standard 1/4" plugs, full metal | – |
| 3.5 mm plugs | | | | |
| NYS 226 | • | | Metal handle with crimp strain relief | 4 mm |
| NYS 226B | • | | With black metal handle | 4 mm |
| NYS 226BG | • | | With black metal handle, gold plated contacts | 4 mm |
| NYS 226G | • | | With gold plated contacts | 4 mm |
| NYS 226L | • | | With large cable outlet | 6 mm |
| NYS 227 | | • | 3.5 mm plug to 1/4" stereo jack adapter, all metal | – |
| NYS 231 | | • | Metal handle with crimp strain relief | 4 mm |
| NYS 231B | | • | With black metal handle | 4 mm |
| NYS 231BG | | • | With black metal handle, gold plated contacts | 4 mm |
| NYS 231G | | • | With gold plated contacts | 4 mm |
| NYS 231L | | • | With large cable outlet | 6 mm |
| NYS 231LBG | | • | With large cable outlet, black metal handle, gold plated contacts | 6 mm |
| NYS 231LL | | • | With x-large cable outlet | 8 mm |
| NYS 231BG-LL | | • | With x-large cable outlet, black metal handle, gold plated contacts | 8 mm |
| Cable jacks | | | | |
| NYS 2202P | • | | 1/4" mono cable jack with metal handle | 6 mm |
| NYS 2203P | | • | 1/4" stereo cable jack with metal handle | 6 mm |
| NYS 240 | | • | 3.5 mm stereo cable jack with metal handle | 4 mm |
| NYS 240BG | | • | With black metal handle, gold plated contacts | 4 mm |
| NYS 240L | | • | With large cable outlet | 6 mm |

Specification

Cable Jacks & 3.5 mm plugs

Adapters

| Electrical | | Cable Jacks & 3.5 mm plugs | Adapters |
|----------------------------|--|---|---|
| Rated current | | depends on mating connector | depends on mating connector |
| Contact resistance | | depends on mating connector | depends on mating connector |
| Insulation resistance | | ≥ 1 GΩ | ≥ 1 GΩ |
| Dielectric strength | | 500 V dc | 500 V dc |
| Mechanical | | Cable Jacks & 3.5 mm plugs | Adapters |
| Lifetime | | 1'000 mating cycles | 1'000 mating cycles |
| Solderability | | complies with IEC68-2-20 | complies with IEC68-2-20 |
| Insertion/withdrawal force | | ≤ 20 N / ≥ 10 N | complies with IEC68-2-20 |
| Operating temperature | | -25°C to +70°C | -25°C to +70°C |
| Material | | Cable Jacks & 3.5 mm plugs | Adapters |
| Housing/handle | - Zinc Diecast Ni/Au/black plated - Brass, Ni/black plated | 3.5 mm plugs cable jacks | • – |
| Insulation | | Thermoplastic | Thermoplastic |
| Contacts | | Brass, Ni / Au plated | Brass, Ni / Au plated |
| Strain relief | | Crimp type SnCe plated | – |
| Part number coding: | B black handle BG ... black handle, gold plated contacts | G gold plated contacts S silent switch | AG all gold, gold plated contacts and shell GT gold plated tip contact |



Phono ("RCA/Cinch")



NYS 352



NYS 354



NYS 355



NYS 373-0

- Heavy duty phono plugs
- All metal
- Cable O.D. up to 7.2 mm
- Cable clamp or chuck type strain relief (NYS373*)
- Phono receptacle for PCB-mounting
- Phono to phono female adapter

NYS 352

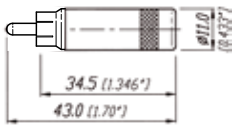

NYS 354

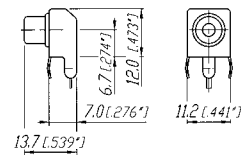

NYS 355

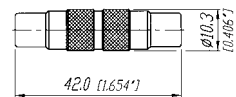

NYS 373-*

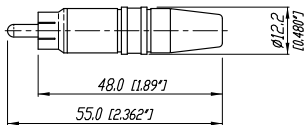

Ordering Information

| Type No. | Description | Cable O.D. |
|---------------------|--|--------------|
| Phono ("RCA/Cinch") | | |
| NYS 352 | Phono plug | 7.2 mm |
| NYS 352AG | Phono plug, all gold plated | 7.2 mm |
| NYS 352B | Phono plug with black metal handle | 7.2 mm |
| NYS 352BG | Phono plug with gold plated contacts and black metal handle | 7.2 mm |
| NYS 352G | Phono plug with gold plated contacts | 7.2 mm |
| NYS 354 | Phono receptacle, PCB-mount, max. panel thickness 1.2 mm | - |
| NYS 355 | Phono to phono female adapter | - |
| NYS 367-* | Phono chassis mount socket, gold plated contacts, color coding | - |
| NYS 372P | Phono jack with nickel plated contacts and handle | 7.2 mm |
| NYS 372P-BG | Phono jack with gold plated contacts and black plated handle | 7.2 mm |
| NYS 373-* | Phono plug with gold plated contacts, black chromium shell, chuck type strain relief | 3.5 – 6.1 mm |

*) 0 - black, 2 - red, 4 - yellow, 5 - green, 6 - blue, 9 - white

Specification

Phono ("RCA/Cinch")

| Electrical | | | | | | | |
|---|---|--|-----------------------------|--|---|----------------------|---------------------------------|
| Rated current | depends on mating connector | | | | | | |
| Contact resistance | depends on mating connector | | | | | | |
| Insulation resistance | ≥ 1 GΩ | | | | | | |
| Dielectric strength | 500 V dc | | | | | | |
| Mechanical | | | | | | | |
| Lifetime | > 1'000 mating cycles | | | | | | |
| Solderability | complies with IEC68-2-20 | | | | | | |
| Operating temperature | -25°C to +70°C | | | | | | |
| Material | | | | | | | |
| Housing/handle | Zinc diecast or Brass Ni / Au / black plated | | | | | | |
| Insulation | Thermoplastic | | | | | | |
| Contacts | Brass, Ni / Au plated | | | | | | |
| Strain relief | - Crimp type SnCe plated • - Chuck tye (POM) | | | | | | |
| Part number coding: | <table style="width: 100%; border: none;"> <tr> <td style="width: 33%;">B black handle</td> <td style="width: 33%;">G gold plated contacts</td> <td style="width: 33%;">AG all gold, gold plated contacts and shell</td> </tr> <tr> <td>BG ... black handle, gold plated contacts</td> <td>S silent switch</td> <td>GT gold plated tip contact</td> </tr> </table> | B black handle | G gold plated contacts | AG all gold, gold plated contacts and shell | BG ... black handle, gold plated contacts | S silent switch | GT gold plated tip contact |
| B black handle | G gold plated contacts | AG all gold, gold plated contacts and shell | | | | | |
| BG ... black handle, gold plated contacts | S silent switch | GT gold plated tip contact | | | | | |



DIN Connectors



NYS 321



NYS 325

- Male cable connectors with rugged diecast shell
- Flexible bushing
- Gold or silver plated non-tarnishing contacts
- Heavy duty cable clamp
- Female receptacle, stamped housing
- Complete shielding with ground contact
- Nickel-plated shell

NYS 321

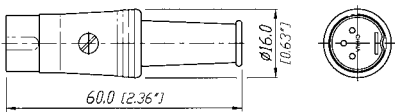

NYS 324

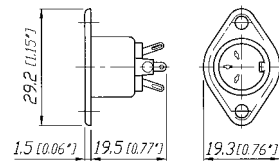

Ordering Information

| Type No. | Description | Cable O.D. |
|--------------------------------------|--|------------|
| DIN male cable connectors | | |
| NYS 321 | 3 pole, with silver plated contacts | 5.0 mm |
| NYS 321G | 3 pole with gold plated contacts | 5.0 mm |
| NYS 322 | 5 pole, with silver plated contacts | 5.0 mm |
| NYS 322G | 5 pole with gold plated contacts | 5.0 mm |
| NYS 322AG | 5 pole with gold plated shell and contacts | 5.0 mm |
| NYS 323 | 7 pole, with silver plated contacts | 5.0 mm |
| NYS 323G | 7 pole, with gold plated contacts | 5.0 mm |
| DIN female chassis connectors | | |
| NYS 324 | 3 pole, with silver plated contacts | - |
| NYS 325 | 5 pole, with silver plated contacts | - |
| NYS 326 | 7 pole, with silver plated contacts | - |

Specification

DIN connectors

| Electrical | |
|-----------------------|---|
| Rated current | depends on mating connector |
| Contact resistance | depends on mating connector |
| Insulation resistance | ≥ 1 GΩ |
| Dielectric strength | 500 V dc |
| Mechanical | |
| Lifetime | > 1'000 mating cycles |
| Cable O.D. | 5 mm |
| Solderability | complies with IEC68-2-20 |
| Operating temperature | -25°C to +70°C |
| Material | |
| Housing/handle | - Zinc diecast Ni/Au plated - Steel, Ni plated |
| Insulation | Thermoplastic |
| Contacts | Brass, Ni / Au plated |
| Strain relief | Crimp type Zn plated |
| Part number coding: | B black handle G.... gold plated contacts AG all gold, gold plated contacts and shell BG ... black handle, gold plated contacts S silent switch GT gold plated tip contact |

Patch Box & Stage Boxes



Patch Box



NYS-SSR-8

- "The Easy Way to Link your Audio System"
- 1/4" Patch box with 8 send/return moduls (split print)
- Metal housing – reliable and robust
- Easy to assemble, simple to use

NYS SSR-8

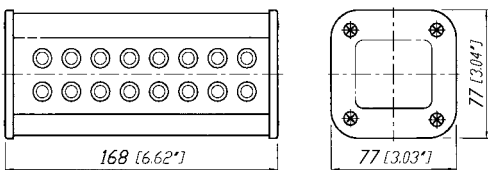

Stage Boxes



NSB2A-20/4



NSB2B-12/4



NSB1C-8/0

- Modular system for individual size and configuration
- Designed to be in an individual combination of connectors for "IN" and "OUT" and length
- Easy to assemble
- 3 pole XLR IDC receptacles eliminate stripping and tinning of wires
- Luminescent, self-adhesive labels for connector identification
- Extremely price competitive

Type A

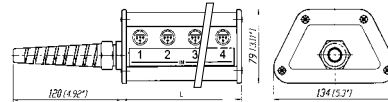

| Type A | L |
|--------|--------------|
| NSB1A | 132 (5.2') |
| NSB2A | 252 (9.93') |
| NSB3A | 372 (14.65') |
| NSB4A | 491 (19.33') |

Type B

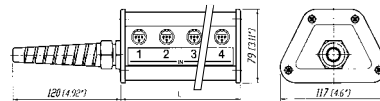

| Type B | L |
|--------|--------------|
| NSB1B | 132 (5.2') |
| NSB2B | 252 (9.93') |
| NSB3B | 372 (14.65') |

Type C

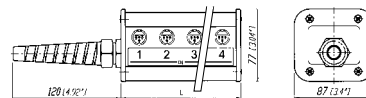

| Type C | L |
|--------|--------------|
| NSB1C | 132 (5.2') |
| NSB2C | 252 (9.93') |
| NSB3C | 372 (14.65') |

Ordering Information

Patch box

| | |
|-----------|--|
| NYS-SSR-8 | 1/4" patch box with 8 send/return moduls (split print) |
|-----------|--|

Stage boxes – type A

| | |
|------------|---|
| NSB1A-8/4 | Length 1, 8 IN (female/send) and 4 OUT (male/return) |
| NSB2A-12/4 | Length 2, 12 IN (female/send) and 4 OUT (male/return) |
| NSB2A-20/4 | Length 2, 20 IN (female/send) and 4 OUT (male/return) |
| NSB3A-32/4 | Length 3, 32 IN (female/send) and 4 OUT (male/return) |
| NSB4A-40/4 | Length 4, 40 IN (female/send) and 4 OUT (male/return) |
| NSB4A-40/8 | Length 4, 40 IN (female/send) and 8 OUT (male/return) |

Stage boxes – type B

| | |
|------------|---|
| NSB1B-8/0 | Length 1, 8 IN (female/send) |
| NSB2B-12/4 | Length 2, 12 IN (female/send) and 4 OUT (male/return) |
| NSB2B-16/0 | Length 2, 16 IN (female/send) |
| NSB3B-20/4 | Length 3, 20 IN (female/send) and 4 OUT (male/return) |

Stage boxes – type C

| | |
|------------|---|
| NSB1C-8/0 | Length 1, 8 IN (female/send) |
| NSB2C-12/4 | Length 2, 12 IN (female/send) and 4 OUT (male/return) |
| NSB3C-20/4 | Length 3, 20 IN (female/send) and 4 OUT (male/return) |

(Supplied as disassembled set comprising of all hardware parts including plates, profiles, strain relief, endpieces and screws.)

Specification

1/4" patch box

Stage boxes

Electrical

| | | | |
|-----------------------|-----------------------------|----------|----------|
| Rated current | depends on mating connector | • | 2 A |
| Contact resistance | depends on mating connector | • | < 5 mΩ |
| Insulation resistance | | ≥ 1 GΩ | ≥ 1 GΩ |
| Dielectric strength | | 500 V dc | 500 V dc |

Mechanical

| | | | |
|----------------------------|--|------------------------|---|
| Lifetime | | > 10'000 mating cycles | > 1'000 mating cycles |
| Insertion/withdrawal force | | ≤ 10 N / ≥ 10 N | ≤ 10 N / ≥ 10 N |
| Multicore cable O.D. | | – | 15/20 mm |
| Applicable wire size | | – | 0.22 mm ² / 24 AWG and 0.14 mm ² / 26 AWG |
| Operating temperature | | -25°C to + 70°C | -25°C to + 70°C |

Material

| | | | |
|---------------------|--|---|---|
| Housing | | Aluminium | Aluminium |
| Quad plates | | – | POM |
| End pieces | | Thermoplastic | Thermoplastic |
| Contacts | Brass/Bronze | Ni plated | Au plated |
| Part number coding: | B black handle BG ... black handle, gold plated contacts | G gold plated contacts S silent switch | AG all gold, gold plated contacts and shell GT gold plated tip contact |

Dual Banana Plugs

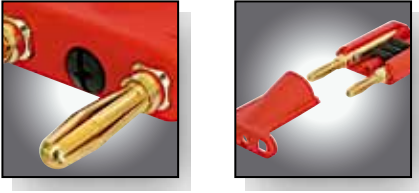

Dual Banana Plugs



NYS 508-R



NYS 508-B

- Cable strain relief: teathed cable clamp featuring cable O.D. 6.0–10.5 mm
- Protection against electric shock: cable ends and plugs are completely covered in mated condition
- Gold plated contacts for tarnish resistance & long insertion life

NYS 508-*

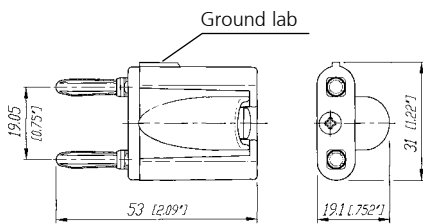

Dual Banana Plugs

Ordering Information

| Type No. | Description | Cable O.D. |
|-------------------|---------------------------------|---------------|
| Dual banana plugs | | |
| NYS 508-R | Dual banana plug, red housing | 6.0 – 10.5 mm |
| NYS 508-B | Dual banana plug, black housing | 6.0 – 10.5 mm |

Specification

Dual
banana plug

| Electrical | |
|-----------------------|--------------------------|
| Rated current | 20 A |
| Insulation resistance | $\geq 1 \text{ G}\Omega$ |
| Dielectric strength | 500 V dc |

| Mechanical | |
|-----------------------|-----------------------|
| Lifetime | > 1'000 mating cycles |
| Operating temperature | -25°C to +50°C |

| Material | |
|---------------|---------------------|
| Insulation | Thermoplastic |
| Contacts | Brass plated |
| Strain relief | Teethed cable clamp |

| | | | |
|---------------------|---|----------------------------|--|
| Part number coding: | B black handle | G.... gold plated contacts | AG all gold, gold plated contacts and shell |
| | BG ... black handle, gold plated contacts | S silent switch | GT gold plated tip contact |

Liechtenstein (Headquarters)

NEUTRIK AG, Im alten Riet 143, 9494 Schaan
T +423 237 24 24, F +423 232 53 93, neutrik@neutrik.com

Germany /Netherlands /Denmark /Austria

Neutrik Vertriebs GmbH, Felix-Wankel-Strasse 1, 85221 Dachau, Germany
T +49 8131 28 08 90, info@neutrik.de

Great Britain

Neutrik (UK) Ltd., Westridge Business Park, Cothey Way
Ryde, Isle of Wight PO33 1 QT
T +44 1983 811 441, sales@neutrik.co.uk

France

Neutrik France SARL, Rue du Parchamp 13, 92100 Boulogne-Billancourt
T +33 1 41 31 67 50, info@neutrik.fr

USA

Neutrik USA Inc., 4115 Taggart Creek Road, Charlotte, North Carolina, 28208
T +1 704 972 30 50, info@neutrikusa.com

Japan

Neutrik Limited, Yusen-Higashinohonbashi-Ekimaie Bldg., 3-7-19
Higashinohonbashi, Chuo-ku, Tokyo 103
T +81 3 3663 47 33, mail@neutrik.co.jp

Hong Kong

Neutrik Hong Kong LTD., Suite 18, 7th Floor Shatin Galleria
Fotan, Shatin
T +852 2687 6055, neutrik@neutrik.com.hk

China

Ningbo Neutrik Trading Co., Ltd., Shiqi Street, Yinxian Road West
Fengjia Villiage, Yinzhou Area, Ningbo, Zhejiang; 315153
T +86 574 88250488 800, neutrik@neutrik.com.cn

India

Neutrik India Pvt. Ltd., Level 3, Neo Vikram, New Link Road,
Above Audi Show Room, Andheri West, Mumbai, 400058
T +91 982 05 43 424, anklesaria@neutrik.com

Associated companies**Contrik AG**

Steinackerstrasse 35, 8902 Urdorf, Switzerland
T +41 44 736 50 10, contrik@contrik.ch

H. Adam GmbH

Felix-Wankel-Straße 1, 85221 Dachau, Germany
T +49 08131 28 08-0, info@adam-gmbh.de

