

1. Features and Benefits

- Wide operating voltage range: from 2.7V to 24V
- Maximum application flexibility by re-programming of all sensor functions
- Customer End-of-Line programming via VDD pin in the application module for system design optimization
- Lateral sensing by IMC technology
- Wide programmable magnetic Latch/Switch range
- Programmable magnetic hysteresis, active pole, output polarity
- Programmable permanent magnet Temperature Coefficient compensation from 0 to -2000ppm/°C
- Integrated self-diagnostic functions activating dedicated Safe Mode
- Reverse supply voltage protection
- Under-Voltage Lockout protection
- Thermal protection
- Integrated capacitor for PCB less designs
- HW component Qualified according to ISO26262-8:13 for use in safety critical systems

2. Application Examples

- Automotive, Consumer and Industrial
- Wiper motor
- Brake light switch
- Window lifter
- Door lock
- Seatbelt buckle
- Seat positioning
- Sunroof/Tailgate opener
- Transmission applications
- Electrical power steering
- Speed sensing (motorcycles)

3. Ordering Information

Product Code	Temperature Code	Package Code	Option Code	Packing Form Code
MLX92242	L	UA	AAA-000	BU
MLX92242	L	SE	AAA-000	RE
MLX92242	L	UA	AAA-100	BU
MLX92242	L	SE	AAA-200	RE
MLX92242	L	UA	AAA-300	BU

Legend:

Temperature Code: L(-40°C to 150°C)
 Package Code: UA = TO92-3L | SE = TSOT-3L
 Option Code: 000 => Perpendicular sensitive
 100 => Integrated capacitor (UA package only)
 200 => IMC (SE package only)
 300 => Integrated capacitor and IMC (UA package only)
 Packing Form: BU = Bulk | RE = Reel | CA=Papertape in Ammopack | CR=Papertape on Reel
 Ordering example: MLX92242LUA-AAA-x00-BU

4. Functional Diagram

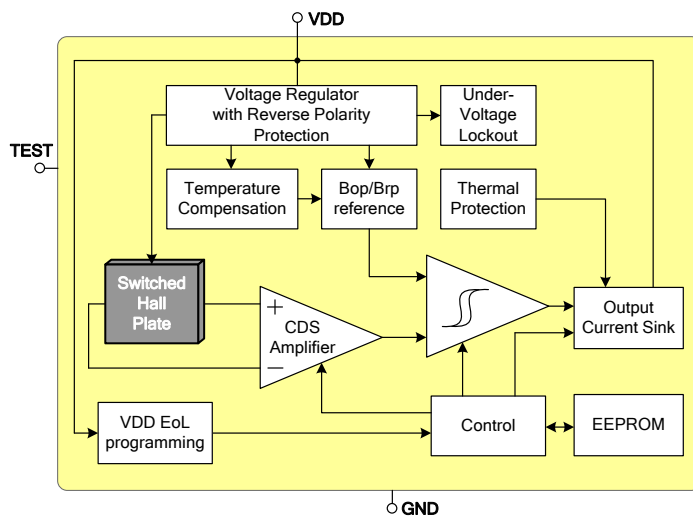

5. General Description

The Melexis MLX92242 is based on the Melexis Hall-effect switch latest platform, designed in mixed signal submicron CMOS technology. The device integrates a voltage regulator, Hall sensor with advanced offset cancellation system and a current sink-configured output driver and integrated capacitor all in a single package. Lateral sensing option is available by using the Melexis IMC technology.

Based on the proven in use platform, the magnetic core is using an improved offset cancellation system allowing faster and more accurate processing while being temperature insensitive and stress independent. In addition a pre-programmable temperature coefficient is implemented to compensate the natural behavior of certain types of magnets becoming weaker with rise in temperature.

The included voltage regulator operates from 2.7 to 24V, hence covering a wide range of applications. With the built-in reverse voltage protection, a serial resistor or diode on the supply line is not required so that even remote sensors can be specified for low voltage operation down to 2.7V while being reverse voltage tolerant.

In an event of a drop below the minimum supply voltage during operation, the under-voltage lock-out protection will automatically freeze the device, preventing the electrical perturbation to affect the magnetic measurement circuitry. The output current state is therefore only updated based on a proper and accurate magnetic measurement result.

The two-wire interface not only saves one wire, but also allows implementation of diagnostic functions as reverse polarity connection and malfunction detection.

The on-chip thermal protection also switches off the output if the junction temperature increases above an abnormally high threshold. It will automatically recover once the temperature decreases below a safe value.

The MLX92242 is delivered in a Green and RoHS compliant Plastic Single-in-Line (TO-92 flat) for through-hole mount, or PCB-less design with integrated capacitor or in 3-pin Thin Small Outline Transistor (TSOT) for surface mount process.

Contents

1. Features and Benefits	1
2. Application Examples	1
3. Ordering Information	1
4. Functional Diagram	2
5. General Description	2
6. Glossary of Terms	4
7. Absolute Maximum Ratings	4
8. General Electrical Specifications	5
9. Magnetic Specifications	6
9.1. MLX92242LUA / LSE-AAA-000 and MLX92242LUA-AAA-100	6
9.2. MLX92242LSE-AAA-200 and MLX92242LUA-AAA-300	7
10. Magnetic Behavior	9
10.1. Latch sensor	9
10.2. Unipolar Switch sensor	9
11. Application Information	10
11.1. Typical Automotive Application Circuit.....	10
11.2. Automotive and Harsh, Noisy Environments Application Circuit.....	10
11.3. Power Dissipation Derating Curve	11
11.4. Voltage Derating Curve.....	11
12. Standard information regarding manufacturability of Melexis products with different soldering processes	12
13. ESD Precautions	12
14. Package Information	13
14.1. SE (TSOT-3L) Package Information	13
14.2. UA (TO92 - 3L) Package Information.....	14
14.3. UA (TO92 - 3L) with integrated capacitor Package Information	15
15. Contact	16
16. Disclaimer	16

6. Glossary of Terms

Tesla	Units for the magnetic flux density, 1 mT = 10 Gauss
TC	Temperature Coefficient in ppm/°C
NC	Not Connected
POR	Power on Reset
IMC	integrated magnetic concentrator (lateral sensing)

7. Absolute Maximum Ratings

Parameter	Symbol	Value	Units
Supply Voltage ^(1, 2)	V _{DD}	+28	V
Supply Voltage (Load Dump) ^(1, 4)	V _{DD}	+32	V
Supply Current ^(1, 2, 3)	I _{DD}	+20	mA
Supply Current ^(1, 3, 4)	I _{DD}	+50	mA
Reverse Supply Voltage ^(1, 2)	V _{DDREV}	-24	V
Reverse Supply Voltage ^(1, 4)	V _{DDREV}	-30	V
Reverse Supply Current ^(1, 2, 5)	I _{DDREV}	-20	mA
Reverse Supply Current ^(1, 4, 5)	I _{DDREV}	-50	mA
Maximum Junction Temperature ⁽⁶⁾	T _J	+165	°C
ESD Sensitivity – HBM ⁽⁷⁾	-	8	kV
ESD Sensitivity – System level ⁽⁸⁾	-	15	kV
ESD Sensitivity – CDM ⁽⁹⁾	-	1000	V
Magnetic Flux Density	B	Unlimited	mT

Exceeding the absolute maximum ratings may cause permanent damage. Exposure to absolute maximum rated conditions for extended periods may affect device reliability.

¹ The maximum junction temperature should not be exceeded

² For maximum 1 hour

³ Including current through protection device

⁴ For maximum 500ms

⁵ Through protection device

⁶ For 1000 hours

⁷ Human Model according AEC-Q100-002 standard

⁸ Indirect discharge according VW TL82466 standard, typical value, only for option MLX92242LUA-AAA-1xx and -3xx

⁹ Charged Device Model according AEC-Q100-011 standard

8. General Electrical Specifications

DC Operating Parameters $V_{DD} = 2.7V$ to $24V$, $T_J = -40^{\circ}C$ to $165^{\circ}C$ (unless otherwise specified)

Parameter	Symbol	Test Conditions	Min	Typ ⁽¹⁾	Max	Units
OFF Supply Current (selectable by a dedicated bit)	I_{OFF}	$V_{DD} = 3.5$ to $24V$	2	-	5	mA
			5	-	6.9	mA
ON Supply Current	I_{ON}	$V_{DD} = 3.5$ to $24V$	12	-	17	mA
Reverse Supply current	I_{DDREV}	$V_{DD} = -16V$	-1	-	-	mA
Safe Mode Supply Current	I_{SAFE}		-	-	1	mA
Supply Current Rise/Fall Time ⁽²⁾	t_R/t_F	$V_{DD} = 12V$, $C_{LOAD} = 50pF$ to GND	0.1	0.3	1	μs
Power-On Time ^(3, 4)	t_{ON}	$V_{DD} = 5V$, $dV_{DD}/dt > 2V/us$, activated output with $>1mT$ overdrive	-	40	70	μs
Chopping Frequency	f_{CHOP}		-	350	-	kHz
Delay Time ^(2, 5)	t_D	Average over 1000 successive switching events @10kHz, Latch, B_{OP} set to 5mT, triangle wave magnetic field with $B > \pm 20mT$	-	7.5	-	μs
Output Jitter (p-p) ^(2, 6)	t_{JITTER}	Over 1000 successive switching events @10kHz, Latch, B_{OP} set to 5mT, triangle wave magnetic field with $B > \pm 20mT$	-	± 3.5	-	μs
Maximum Switching Frequency ^(2, 7)	f_{SW}	Latch, B_{OP} set to 5mT, triangle wave magnetic field with $B > \pm 20mT$	-	50	-	kHz
Under-voltage Lockout Threshold	V_{UVL}		-	-	2.7	V
Under-voltage Lockout Reaction time ⁽²⁾	t_{UVL}		-	1	-	μs
Max Programming Supply Voltage	V_{DDprog}		-	22	28	V
Integrated bypass capacitor	C_{BP}	Only for options MLX92242LUA- AAA-1xx and -3xx	-	68	-	nF
Thermal Protection Activation	T_{PROT}		-	190 ⁽⁸⁾	-	$^{\circ}C$
Thermal Protection Release	T_{REL}		-	180 ⁽⁸⁾	-	$^{\circ}C$
UA Package Thermal Resistance	R_{THJA}		-	200	-	$^{\circ}C/W$
SE Package Thermal Resistance	R_{THJA}		-	300	-	$^{\circ}C/W$

¹ Typical values are defined at $T_A = +25^{\circ}C$ and $V_{DD} = 12V$.

² Guaranteed by design and verified by characterization, not production tested.

³ The Power-On Time represents the time from reaching $V_{DD} = 2.7V$ to the first refresh of the supply current state.

⁴ Power-On Slew Rate is not critical for the proper device start-up.

⁵ The Delay Time is the time from magnetic threshold reached to the start of the output switching.

⁶ Output jitter is the unpredictable deviation of the Delay time.

⁷ Maximum switching frequency corresponds to the maximum frequency of the applied magnetic field which is detected without loss of pulses.

⁸ T_{PROT} and T_{REL} are the corresponding junction temperature values.

9. Magnetic Specifications

9.1. MLX92242LUA / LSE-AAA-000 and MLX92242LUA-AAA-100

DC Operating Parameters $V_{DD} = 3.5V$ to $24V$, $T_J = -40^{\circ}C$ to $150^{\circ}C$ (unless otherwise specified)

Parameter	Symbol	Test Conditions	Min	Typ ⁽¹⁾	Max	Units
Operating Point Range ⁽²⁾	B_{OP}	$V_{DD} = 5V$, $T_J = 25^{\circ}C$	-100	-	100	mT
Factory pre-programmed Operating Point, Switch	B_{OP}	$V_{DD} = 5V$, $T_J = 25^{\circ}C$, programming target 28mT	26	28	30	mT
Factory pre-programmed Release Point, Switch	B_{RP}	$V_{DD} = 5V$, $T_J = 25^{\circ}C$, programming target 28mT, $HYS_{RATIO} = 0.75$	19	21	23	mT
B_{OP} Magnitude Programming ⁽³⁾			-	8	-	bit
B_{OP} Polarity Selection			-	1	-	bit
B_{OP}/B_{RP} Temperature Coefficient Programming Range ^(4,5)	TC ⁽⁶⁾	$V_{DD} = 5V$, Latch with $B_{OP} = 28mT$, $B_{RP} = -28mT$	-2000	-	0	ppm/ $^{\circ}C$
B_{OP}/B_{RP} Temperature Coefficient Programming			-	5	-	bit
Switch/Latch Function Selection			-	1	-	bit
Proportional/Absolute Hysteresis Selection			-	1	-	bit
Hysteresis Programming ⁽⁷⁾			-	5	-	bit
Proportional Hysteresis Ratio Programming Range $HYS_{RATIO} = B_{HYS_{PR}} / B_{OP}$ ⁽⁴⁾	HYS_{RATIO}	Programming step 0.025	0.025	-	0.800	-
Absolute Hysteresis Range ⁽⁴⁾	$B_{HYS_{ABS}}$	Programming step 0.1mT	0	-	3.1	mT
Absolute Hysteresis tolerance ⁽⁸⁾	B_{HYSTOL}	$B_{HYS_{ABS}} = 0.8mT$ to $1.6mT$, $B_{OP} = 3mT$, $V_{DD} = 3.5$ to $14V$	-0.6	0	0.6	mT
Absolute Hysteresis tolerance ⁽⁸⁾	B_{HYSTOL}	$B_{HYS_{ABS}} = 1.7mT$ to $3.1mT$, $B_{OP} = 3mT$, $V_{DD} = 3.5$ to $14V$	-0.7	0	0.7	mT
B_{OP} , B_{RP} and $B_{HYS_{PR}}$ life time drift		HTOL 1000h at $T_J = 165^{\circ}C$	-(4%+0.2mT)		4%+0.2mT	
Output Polarity Selection			-	1	-	Bit
V_{DD} Programming Lock			-	1	-	bit

¹ Typical values are defined at $T_A = +25^{\circ}C$ and $V_{DD} = 5V$

² Guaranteed by correlation with production test at $B = 28mT$ and verified by characterization

³ The programming step is typically from 0.4% to 0.8% of the programmed B_{OP} value for $|B_{OP}| \geq 2mT$ and 0.016mT for $|B_{OP}| \leq 2mT$

⁴ The minimum and maximum limits are typical values

⁵ The factory pre-programmed TC value is -2000 ppm/ $^{\circ}C$

⁶ The B_{OP}/B_{RP} Temperature Coefficient is calculated using the following formula:

$$TC = \frac{(B_{OPT2} - B_{RPT2}) - (B_{OPT1} - B_{RPT1})}{(B_{OPT1} - B_{RPT1}) * (T_2 - T_1)} * 10^6, \frac{ppm}{^{\circ}C}; T_1 = 25^{\circ}C; T_2 = 150^{\circ}C$$

⁷ Programming of very low hysteresis magnitude (<1mT) could lead to output toggling due to noise and mechanical looseness in the magnetic system. As $T_J = T_A + V_{DD} * I_{DD} * R_{THJA}$ the change in the junction temperature due to I_{DD} switching between I_{ON} and I_{OFF} in combination with the device TC could cause B_{OP} or B_{RP} shift. If the chosen magnetic hysteresis is close or below the above shift and inverted output polarity is selected, an output toggling could appear

⁸ Including life time drift. Guaranteed by correlation with production test at $B = 3mT$, $T_J = +25^{\circ}C$ and verified by characterization

9.2. MLX92242LSE-AAA-200 and MLX92242LUA-AAA-300

DC Operating Parameters $V_{DD} = 3.5V$ to $24V$, $T_J = -40^{\circ}C$ to $150^{\circ}C$ (unless otherwise specified)

Parameter	Symbol	Test Conditions	Min	Typ ⁽¹⁾	Max	Units
Operating Point Programming Range ⁽²⁾	B_{OP}	$V_{DD} = 5V$, $T_J = 25^{\circ}C$	-40	-	40	mT
Factory pre-programmed Operating Point, Latch	B_{OP}	$V_{DD} = 5V$, $T_J = 25^{\circ}C$, programming target 12mT	9	12	15	mT
Factory pre-programmed Release Point, Latch	B_{RP}	$V_{DD} = 5V$, $T_J = 25^{\circ}C$, programming target 12mT	-15	-12	-9	mT
B_{OP} Magnitude Programming ⁽³⁾			-	8	-	bit
B_{OP} Polarity Selection			-	1	-	bit
B_{OP}/B_{RP} Temperature Coefficient Programming Range ^(4, 5)	TC ⁽⁶⁾	$V_{DD} = 5V$, Latch with $B_{OP} = 12mT$, $B_{RP} = -12mT$	-2000	-	0	ppm/ $^{\circ}C$
B_{OP}/B_{RP} Temperature Coefficient Programming			-	5	-	bit
Switch/Latch Function Selection			-	1	-	bit
Proportional/Absolute Hysteresis Selection			-	1	-	bit
Hysteresis Magnitude Programming ⁽⁷⁾			-	5	-	bit
Proportional Hysteresis Ratio Programming Range ⁽⁴⁾ $HYS_{RATIO} = B_{HYSRP} / B_{OP}$	HYS_{RATIO}	Programming step 0.025	0.025	-	0.800	-
Absolute Hysteresis Programming Range ⁽⁴⁾	B_{HYSABS}	Programming step 0.1mT	0	-	3.1	mT
Absolute Hysteresis tolerance ⁽⁸⁾	B_{HYSTOL}	$B_{HYSABS} = 1.5mT$ to $3.1mT$, $B_{OP} = 3mT$, $V_{DD} = 3.5$ to $14V$	-1.2	-	1.2	mT
B_{OP} , B_{RP} and B_{HYS} life time drift		HTOL 1000h at $T_J = 165^{\circ}C$	-	(4%+0.2 mT)	4%+0.2mT	
Output Polarity Selection			-	1	-	bit
V_{DD} Programming Lock			-	1	-	bit

¹ Typical values are defined at $T_A = +25^{\circ}C$ and $V_{DD} = 5V$

² Guaranteed by correlation with production test at $B = 12mT$ and verified by characterization

³ The programming step is typically from 0.4% to 0.8% of the programmed B_{OP} value for $|B_{OP}| \geq 2mT$ and 0.016mT for $|B_{OP}| \leq 2mT$

⁴ The minimum and maximum limits are typical values

⁵ The factory pre-programmed TC value is 0 ppm/ $^{\circ}C$

⁶ The B_{OP}/B_{RP} Temperature Coefficient is calculated using the following formula:

$$TC = \frac{(B_{OPT2} - B_{RPT2}) - (B_{OPT1} - B_{RPT1})}{(B_{OPT1} - B_{RPT1}) * (T_2 - T_1)} * 10^6, \frac{ppm}{^{\circ}C}; T_1 = 25^{\circ}C; T_2 = 150^{\circ}C$$

⁷ Programming of very low hysteresis magnitude (<1.5mT) could lead to output toggling due to noise and mechanical looseness in the magnetic system. As $T_J = T_A + V_{DD} * I_{DD} * R_{THJA}$ the change in the junction temperature due to I_{DD} switching between I_{ON} and I_{OFF} in combination with the device TC could cause B_{OP} or B_{RP} shift. If the chosen magnetic hysteresis is close or below the above shift and inverted output polarity is selected, an output toggling could appear

⁸ Guaranteed by correlation with production test at $B = 3mT$, $T_J = +25^{\circ}C$ and verified by characterization

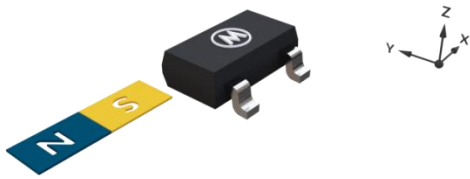

South active pole (IMC version)

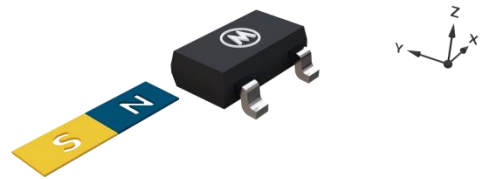

North active pole (IMC version)

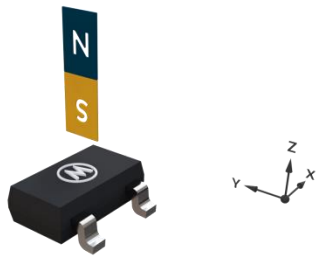

South active pole

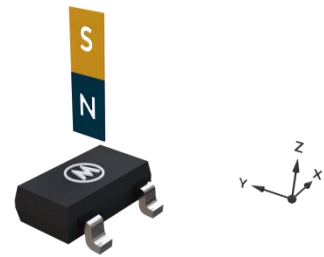

North active pole

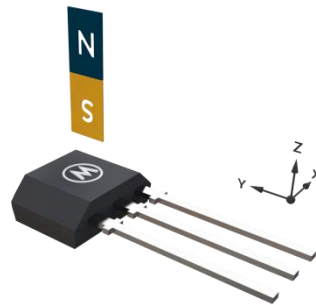

South active pole

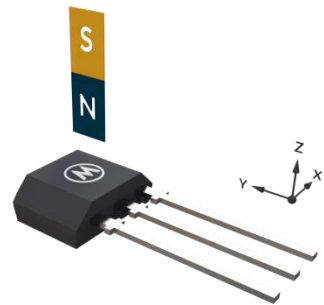

North active pole

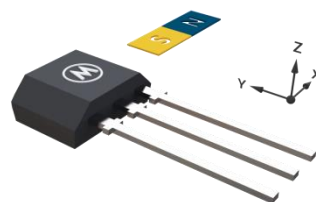

South active pole (IMC version)

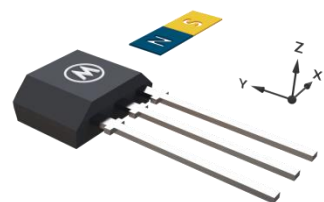

North active pole (IMC version)

10. Magnetic Behavior

10.1. Latch sensor

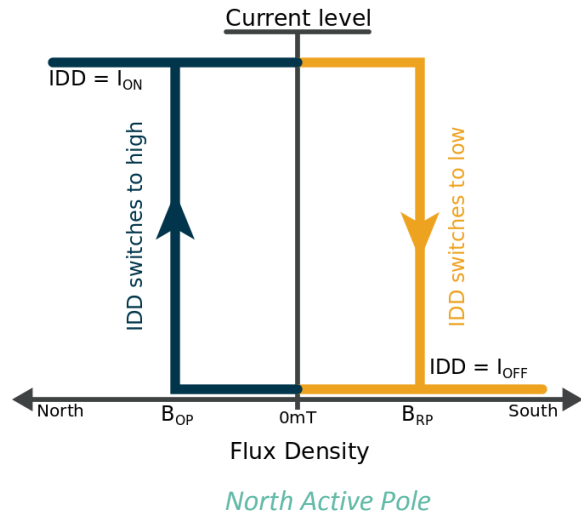
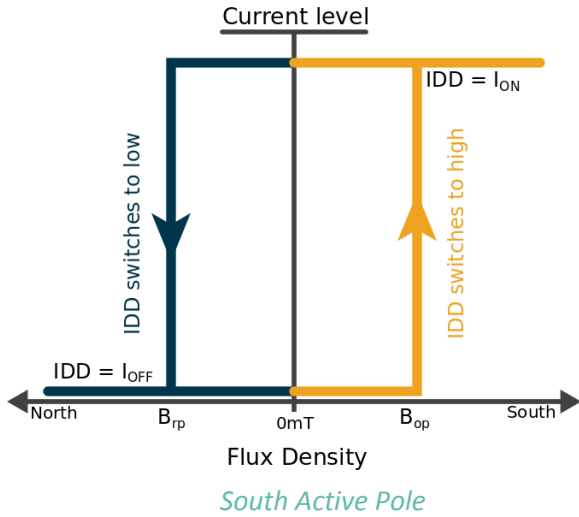

10.2. Unipolar Switch sensor

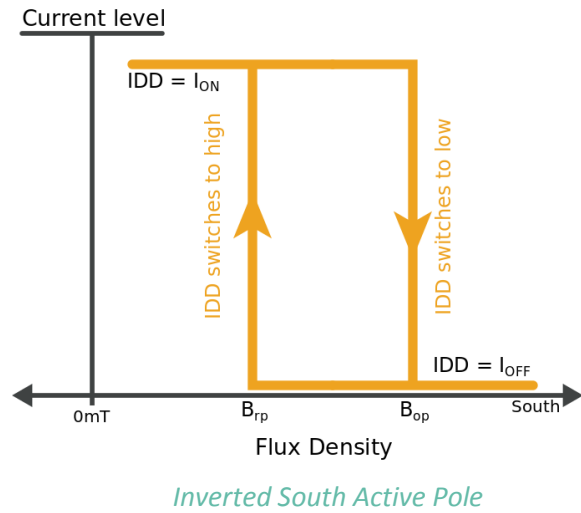
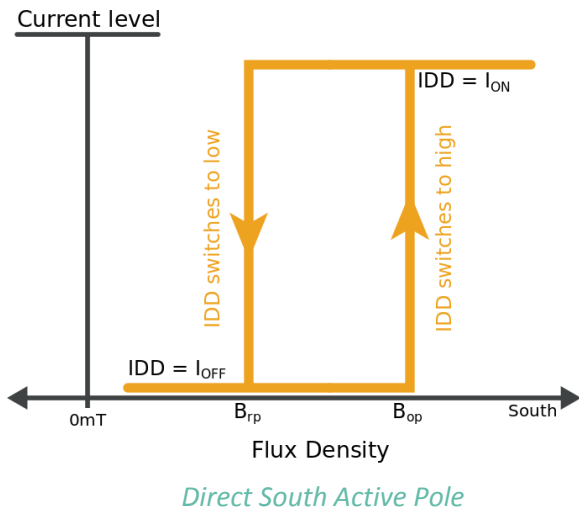

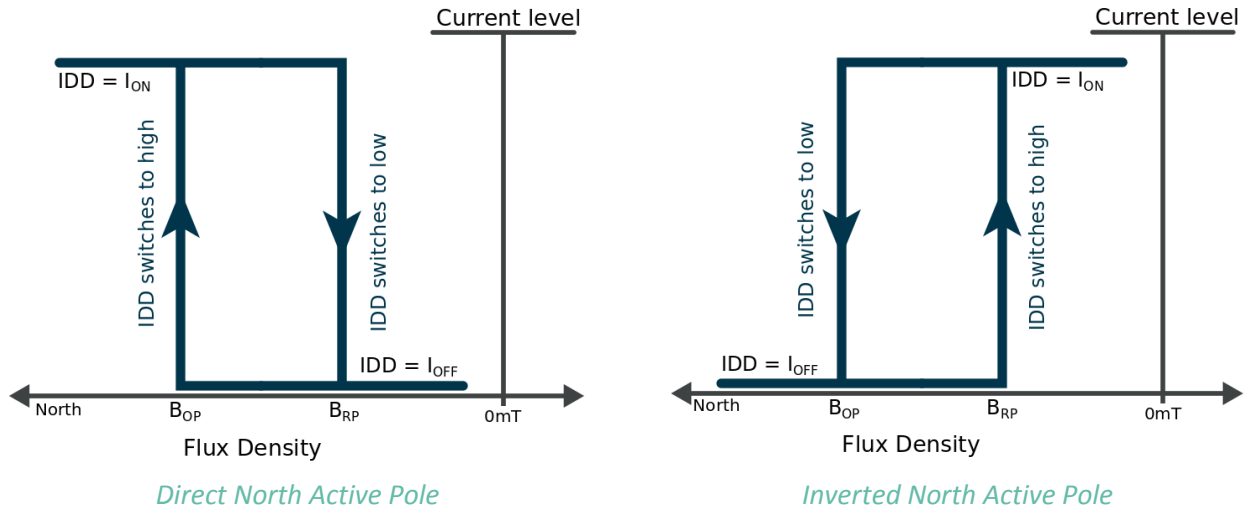

11. Application Information

11.1. Typical Automotive Application Circuit

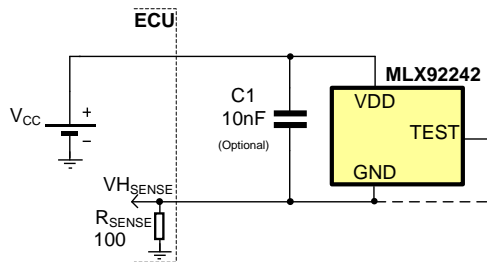

Notes:

1. For proper operation, a 10 to 100nF bypass capacitor should be placed as close as possible to the V_{DD} and ground (GND) pin. For MLX92242LUA-AAA-1xx and -3xx C1 is not required.
2. The TEST pin is to be connected to GND or left open.

11.2. Automotive and Harsh, Noisy Environments Application Circuit

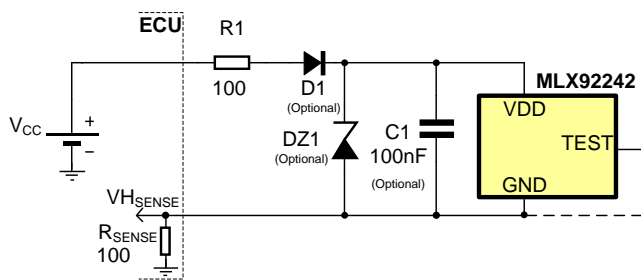

Notes:

1. For proper operation, a 10 to 100nF bypass capacitor should be placed as close as possible to the V_{DD} and ground (GND) pin. For MLX92242LUA-AAA-1xx and -3xx C1 is not required.
2. The device can tolerate positive voltages up to +28 (+32)V and negative voltages down to -24 (-30)V. If bigger transients over the supply line are expected the usage of D1 and DZ1 (24...27V) is recommended. The series resistor R1 is used to limit the current through DZ1 and to improve the EMC performance.

11.3. Power Dissipation Derating Curve

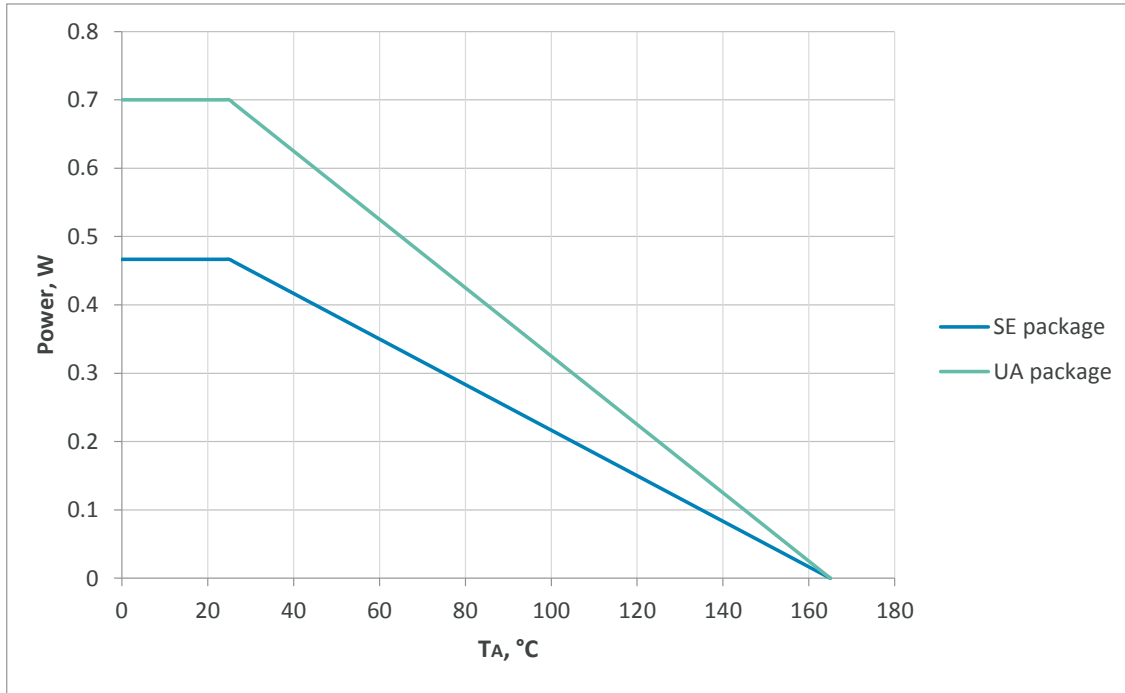

11.4. Voltage Derating Curve

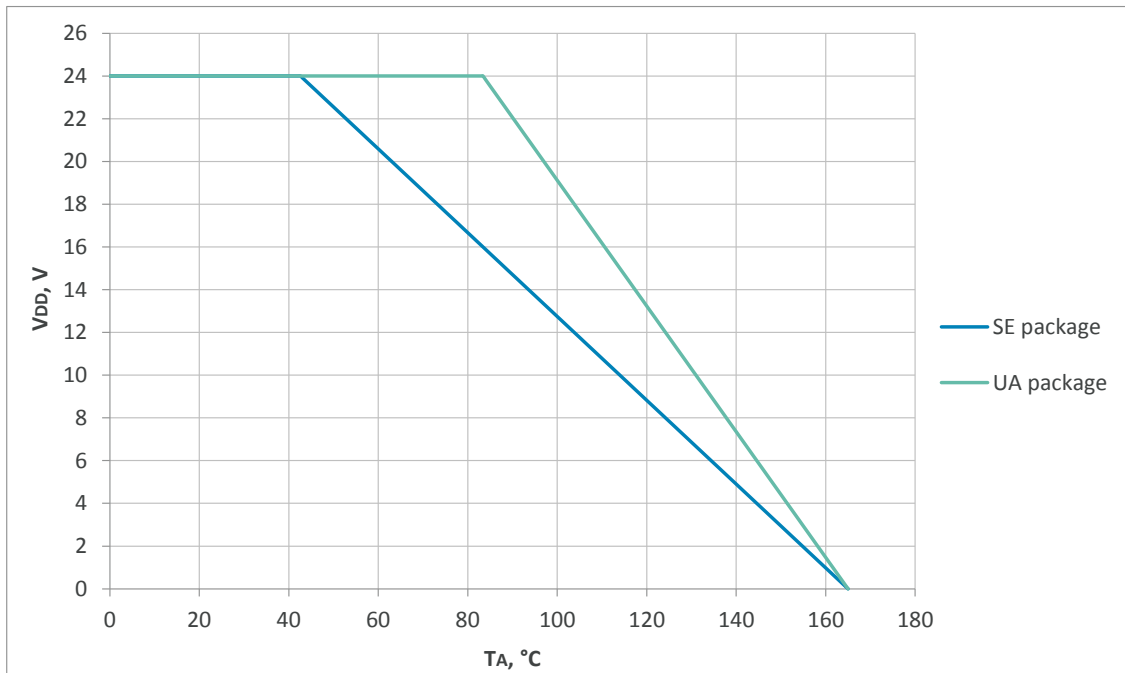

12. Standard information regarding manufacturability of Melexis products with different soldering processes

Our products are classified and qualified regarding soldering technology, solderability and moisture sensitivity level according to following test methods:

Reflow Soldering SMD's (Surface Mount DeVICES)

- IPC/JEDEC J-STD-020
Moisture/Reflow Sensitivity Classification for Nonhermetic Solid State Surface Mount Devices (classification reflow profiles according to table 5-2)
- EIA/JEDEC JESD22-A113
Preconditioning of Nonhermetic Surface Mount Devices Prior to Reliability Testing (reflow profiles according to table 2)

Wave Soldering SMD's (Surface Mount DeVICES) and THD's (Through Hole DeVICES)

- EN60749-20
Resistance of plastic- encapsulated SMD's to combined effect of moisture and soldering heat
- EIA/JEDEC JESD22-B106 and EN60749-15
Resistance to soldering temperature for through-hole mounted devices

Iron Soldering THD's (Through Hole DeVICES)

- EN60749-15
Resistance to soldering temperature for through-hole mounted devices

Solderability SMD's (Surface Mount DeVICES) and THD's (Through Hole DeVICES)

- EIA/JEDEC JESD22-B102 and EN60749-21
Solderability

For all soldering technologies deviating from above mentioned standard conditions (regarding peak temperature, temperature gradient, temperature profile etc) additional classification and qualification tests have to be agreed upon with Melexis.

The application of Wave Soldering for SMD's is allowed only after consulting Melexis regarding assurance of adhesive strength between device and board.

Melexis recommends reviewing on our web site the General Guidelines [soldering recommendation](http://www.melexis.com/Quality_soldering.aspx) (http://www.melexis.com/Quality_soldering.aspx) as well as [trim&form recommendations](http://www.melexis.com/Assets/Trim-and-form-recommendations-5565.aspx) (<http://www.melexis.com/Assets/Trim-and-form-recommendations-5565.aspx>).

Melexis is contributing to global environmental conservation by promoting **lead free** solutions. For more information on qualifications of **RoHS** compliant products (RoHS = European directive on the Restriction Of the use of certain Hazardous Substances) please visit the quality page on our website: <http://www.melexis.com/quality.aspx>

13. ESD Precautions

Electronic semiconductor products are sensitive to Electro Static Discharge (ESD). Always observe Electro Static Discharge control procedures whenever handling semiconductor products.

14. Package Information

14.1. SE (TSOT-3L) Package Information

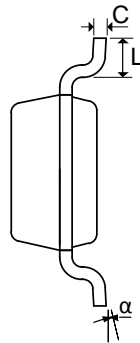
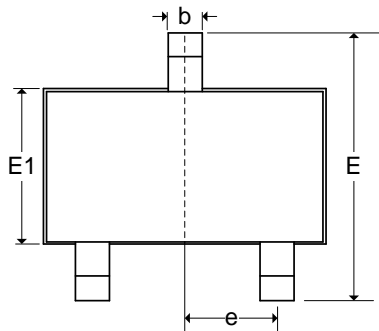

Notes:

1. All dimensions are in millimeters
2. Outermost plastic extreme width does not include mold flash or protrusions. Mold flash and protrusions shall not exceed 0.15mm per side.
3. Outermost plastic extreme length does not include mold flash or protrusions. Mold flash and protrusions shall not exceed 0.25mm per side.
4. The lead width dimension does not include dambar protrusion. Allowable dambar protrusion shall be 0.07mm total in excess of the lead width dimension at maximum material condition.
5. Dimension is the length of terminal for soldering to a substrate.
6. Formed lead shall be planar with respect to one another with 0.076mm at seating plane.

Marking:

TOP:

Option -0xx: 42WW

Option -2xx: 43WW

WW: Assembly week

BOTTOM:

YLLL

Y: Assembly Year

LLL: Last 3 digits from lot#

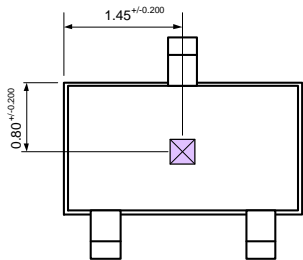
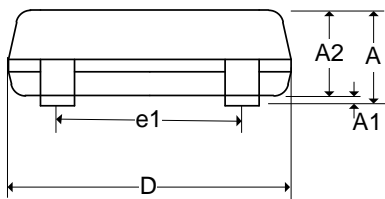

Hall plate location

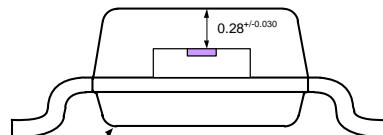

Notes:

1. All dimensions are in millimeters
2. XY Hall plate position tolerances do not include the mold flashes and protrusions described in the package drawing

TOP VIEW

END VIEW

	A	A1	A2	D	E	E1	L	b	c	e	e1	α
min	–	0.025	0.85	2.80	2.60	1.50	0.30	0.30	0.10	0.95	1.90	0°
max	1.00	0.10	0.90	3.00	3.00	1.70	0.50	0.45	0.20	BSC	BSC	8°

Notes:

1. Dimension “D” and “E1” do not include mold flash or protrusions. Mold flash or protrusion shall not exceed 0.15mm on “D” and 0.25mm on “E” per side.
2. Dimension “b” does not include dambar protrusion.

SE Pin №	Name	Type	Function
1	VDD	Supply	Supply Voltage pin
2	TEST	I/O	For Melexis use only
3	GND	Ground	Ground pin

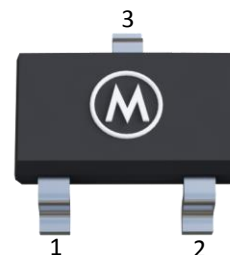

14.2. UA (TO92 - 3L) Package Information

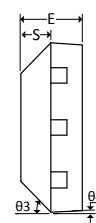
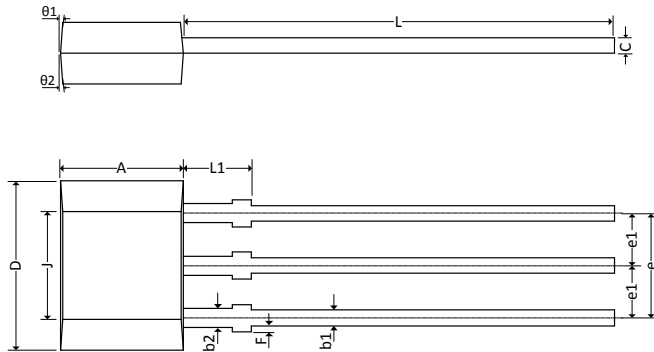

Marking:
 1st Line : 42WW
 42: referring to design number
 WW: calendar week number
 2nd Line : YLLL
 Y - last digit of year
 LLL – Last three digits of lot number

Hall plate location

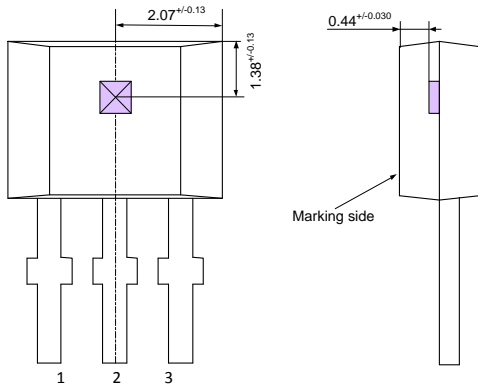

	A	D	E	F	J	L	L1	S	b1	b2	c	e	e1
min	2.80	3.90	1.40	0.00	2.51	14.0	0.90	0.63	0.35	0.43	0.35	2.51	1.24
max	3.20	4.30	1.60	0.15	2.72	15.0	1.10	0.84	0.44	0.52	0.44	2.57	1.30
	theta1	theta2	theta3	theta4									
min	7°	7°	45°	7°									
max	REF	REF	REF	REF									

Notes:

1. All dimensions are in millimeters.
2. Mold flashes and protrusion are not included.
3. Gate burrs shall not exceed 0.127mm on the top side.

UA Pin №	Name	Type	Function
1	VDD	Supply	Supply Voltage pin
2	GND	Ground	Ground pin
3	TEST	I/O	For Melexis use only



14.3. UA (TO92 - 3L) with integrated capacitor Package Information

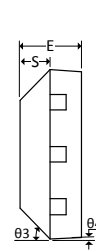
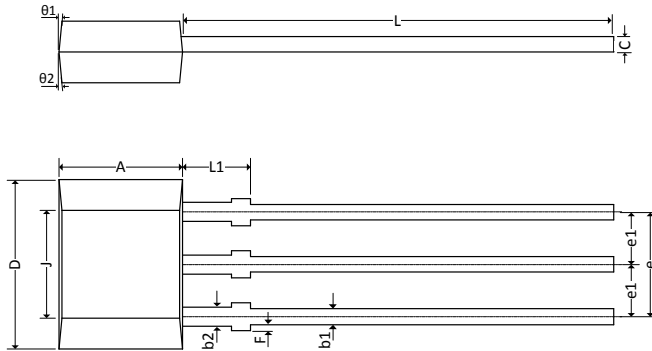

Marking:

Top:

1st Line :

Option -1xx: C1WW, WW - calendar week

Option -3xx: C4WW, WW - calendar week

2nd Line : YLLL: → Y - last digit of year

LLL - 4th up to 6th characters of mother wafer lot#

Hall plate location

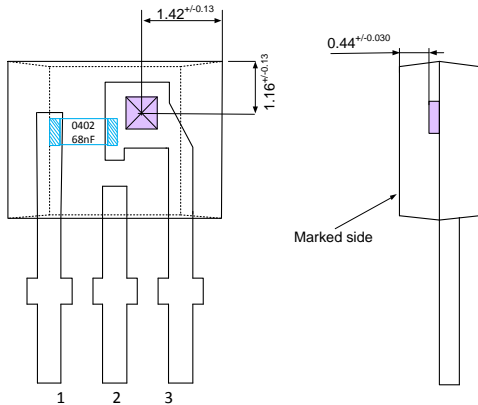

	A	D	E	F	J	L	L1	S	b1	b2	c	e	e1
min	2.80	3.90	1.40	0.00	2.51	14.0	0.90	0.63	0.35	0.43	0.35	2.51	1.24
max	3.20	4.30	1.60	0.15	2.72	15.0	1.10	0.84	0.44	0.52	0.44	2.57	1.30
	theta1	theta2	theta3	theta4									
min	7°	7°	45°	7°									
max	REF	REF	REF	REF									

Notes:

1. All dimensions are in millimeters
2. Mold flashes and protrusion are not included.
3. Gate burrs shall not exceed 0.127mm on the top side.

UA Pin №	Name	Type	Function
1	VDD	Supply	Supply Voltage pin
2	TEST	I/O	For Melexis use only
3	GND	Ground	Ground pin



15. Contact

For the latest version of this document, go to our website at www.melexis.com.

For additional information, please contact our Direct Sales team and get help for your specific needs:

Europe, Africa	Telephone: +32 13 67 04 95
	Email : sales_europe@melexis.com
Americas	Telephone: +1 603 223 2362
	Email : sales_usa@melexis.com
Asia	Email : sales_asia@melexis.com

16. Disclaimer

The information furnished by Melexis herein ("Information") is believed to be correct and accurate. Melexis disclaims (i) any and all liability in connection with or arising out of the furnishing, performance or use of the technical data or use of the product(s) as described herein ("Product") (ii) any and all liability, including without limitation, special, consequential or incidental damages, and (iii) any and all warranties, express, statutory, implied, or by description, including warranties of fitness for particular purpose, non-infringement and merchantability. No obligation or liability shall arise or flow out of Melexis' rendering of technical or other services.

The Information is provided "as is" and Melexis reserves the right to change the Information at any time and without notice. Therefore, before placing orders and/or prior to designing the Product into a system, users or any third party should obtain the latest version of the relevant information to verify that the information being relied upon is current.

Users or any third party must further determine the suitability of the Product for its application, including the level of reliability required and determine whether it is fit for a particular purpose.

The Information is proprietary and/or confidential information of Melexis and the use thereof or anything described by the Information does not grant, explicitly or implicitly, to any party any patent rights, licenses, or any other intellectual property rights.

This document as well as the Product(s) may be subject to export control regulations. Please be aware that export might require a prior authorization from competent authorities.

The Product(s) are intended for use in normal commercial applications. Unless otherwise agreed upon in writing, the Product(s) are not designed, authorized or warranted to be suitable in applications requiring extended temperature range and/or unusual environmental requirements. High reliability applications, such as medical life-support or life-sustaining equipment are specifically not recommended by Melexis.

The Product(s) may not be used for the following applications subject to export control regulations: the development, production, processing, operation, maintenance, storage, recognition or proliferation of 1) chemical, biological or nuclear weapons, or for the development, production, maintenance or storage of missiles for such weapons; 2) civil firearms, including spare parts or ammunition for such arms; 3) defense related products, or other material for military use or for law enforcement; 4) any applications that, alone or in combination with other goods, substances or organisms could cause serious harm to persons or goods and that can be used as a means of violence in an armed conflict or any similar violent situation.

The Products sold by Melexis are subject to the terms and conditions as specified in the Terms of Sale, which can be found at <https://www.melexis.com/en/legal/terms-and-conditions>.

This document supersedes and replaces all prior information regarding the Product(s) and/or previous versions of this document.

Melexis NV © - No part of this document may be reproduced without the prior written consent of Melexis. (2016)

ISO/TS 16949 and ISO14001 Certified