

R Series Attachment

BASE Attachment

| Plate model | Applicable models |
|-------------|-------------------|
| F-R10-1 | R10A |
| F-R15-1 | R15A |
| F-R25-1 | R25A |
| F-R50-1 | R50A |
| F-R100-1 | R100 |
| F-R150-1 | R150 |

Example
(R100)

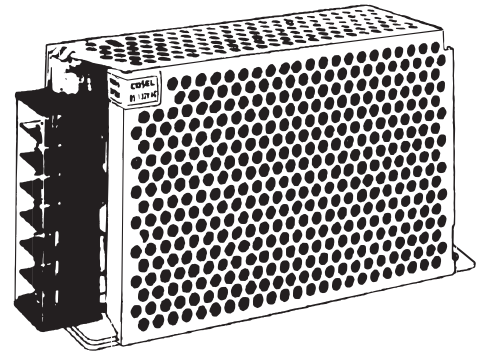

< TOP VIEW > (Unit : mm) (Tolerance : ±1)

| | |
|--|--|
| <p>F-R10-1</p> <p>Size</p> <ul style="list-style-type: none"> * Material : SPCC * Thickness : 2.0 * Weight : 40g max | <p>F-R15-1</p> <p>Size</p> <ul style="list-style-type: none"> * Material : SPCC * Thickness : 2.0 * Weight : 50g max |
| <p>* M3 Flat screw is requested when mounting. Please check the instruction manual for the size of screw.</p> | |
| <p>Mounting hole size</p> <p>FRONT←</p> | <p>Mounting hole size</p> <p>FRONT←</p> |
| <p>F-R25-1</p> <p>Size</p> <ul style="list-style-type: none"> * Material : SPCC * Thickness : 2.0 * Weight : 65g max | <p>F-R50-1</p> <p>Size</p> <ul style="list-style-type: none"> * Material : SPCC * Thickness : 2.0 * Weight : 80g max |
| <p>* M3 Flat screw is requested when mounting. Please check the instruction manual for the size of screw.</p> | |
| <p>Mounting hole size</p> <p>FRONT←</p> | <p>Mounting hole size</p> <p>FRONT←</p> |
| <p>F-R100-1</p> <p>Size</p> <ul style="list-style-type: none"> * Material : SPCC * Thickness : 2.0 * Weight : 110g max | <p>F-R150-1</p> <p>Size</p> <ul style="list-style-type: none"> * Material : SPCC * Thickness : 2.0 * Weight : 150g max |
| <p>* M4 Flat screw is requested when mounting. Please check the instruction manual for the size of screw.</p> | |
| <p>Mounting hole size</p> <p>FRONT←</p> | <p>Mounting hole size</p> <p>FRONT←</p> |

FRONT · REVERSE
Attachment

| Plate model | Applicable models |
|-------------|-------------------|
| F-K10-2 | R10A |
| F-R15-2 | R15A |
| F-R25-2 | R25A |
| F-R50-2 | R50A |
| F-R100-2 | R100 |
| F-R150-2 | R150 |

Example

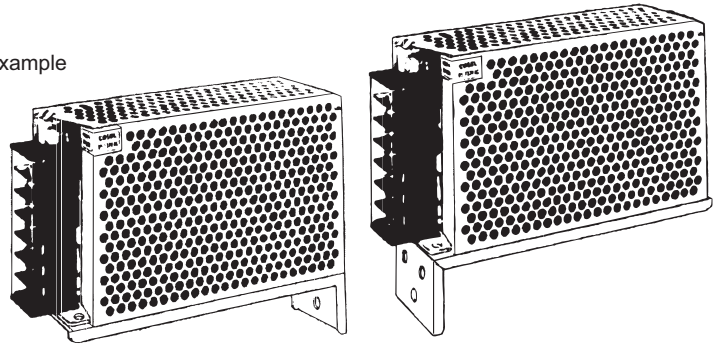

< TOP VIEW > (Unit : mm) (Tolerance : ±1)

| | |
|--|--|
| <p style="text-align: center;">F-K10-2</p> <p>Size</p> <ul style="list-style-type: none"> ★ Material : SPCC ★ Thickness : 1.6 ★ Weight : 60g max | <p style="text-align: center;">F-R15-2</p> <p>Size</p> <ul style="list-style-type: none"> ★ Material : SPCC ★ Thickness : 1.6 ★ Weight : 75g max |
| <p>★ M3 screw is requested when mounting. Please check the instruction manual for the size of screw.</p> | |
| <p style="text-align: center;">F-R25-2</p> <p>Size</p> <ul style="list-style-type: none"> ★ Material : SPCC ★ Thickness : 1.6 ★ Weight : 85g max | <p style="text-align: center;">F-R50-2</p> <p>Size</p> <ul style="list-style-type: none"> ★ Material : SPCC ★ Thickness : 1.6 ★ Weight : 100g max |
| <p>★ M3 screw is requested when mounting. Please check the instruction manual for the size of screw.</p> | |
| <p style="text-align: center;">F-R100-2</p> <p>Size</p> <ul style="list-style-type: none"> ★ Material : SPCC ★ Thickness : 1.6 ★ Weight : 130g max | <p style="text-align: center;">F-R150-2</p> <p>Size</p> <ul style="list-style-type: none"> ★ Material : SPCC ★ Thickness : 2.0 ★ Weight : 220g max |
| <p>★ M4 screw is requested when mounting. Please check the instruction manual for the size of screw.</p> | |

Din rail Attachment Plate

APPLICABLE TO MODEL

Din rail width : 35mm

| Plate model | Model | screws for installation | |
|-------------|---|-------------------------|------|
| | | Type | Qty |
| FD-A | R50A RMB30A, RMC30A | M3 | 2pcs |
| FD-B | MMC8A R10A, R15A, R25A RMB15A, RMC15A | M3 | 2pcs |

EXTERNAL VIEW

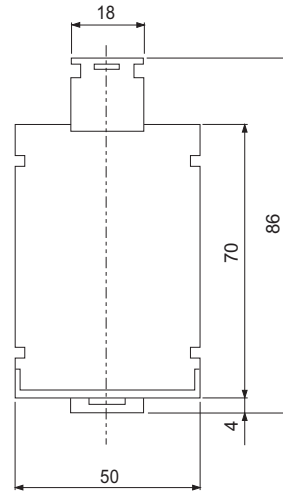
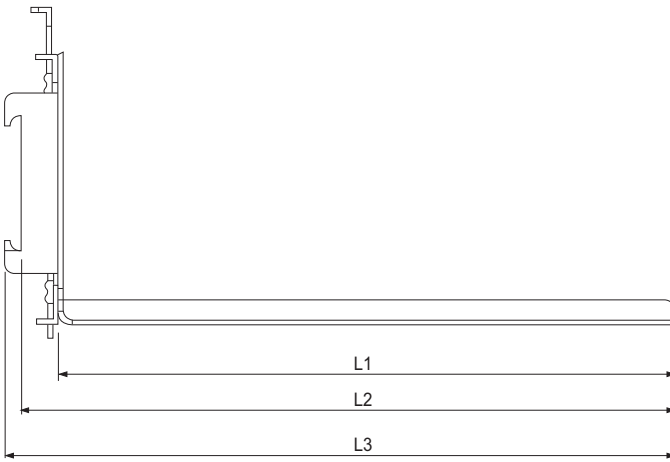

- * Material : SPCC
- * Thickness : 1.6
- * Tolerance : ±1
- * Weight : FD-A 290g max
FD-B 240g max

(Unit : mm)

| Model | L1 | L2 | L3 |
|-------|-----|-------|-------|
| FD-A | 165 | 174.5 | 178.6 |
| FD-B | 115 | 124.5 | 128.6 |

DIN RAIL ATTACHMENT MODEL : FD-SP

MOUNTING EXAMPLE

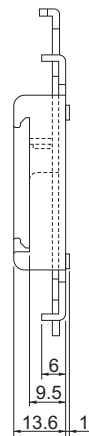
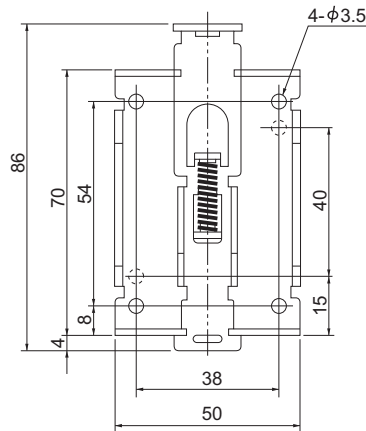
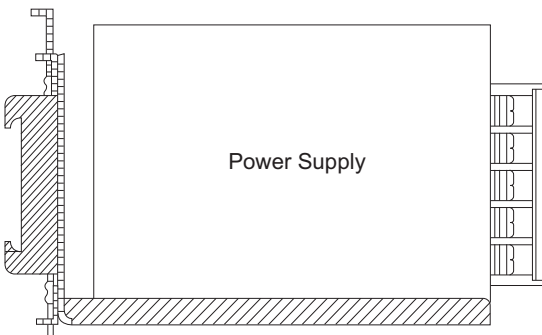

- * Material : SPCC
- * Thickness : 1.6
- * Tolerance : ±1
- * Weight : 85g max

Harness for input/output(J type) is prepared in R series.

R Series
RMB Series
RMC Series

Mating harness

| Model | Harness model # | |
|------------------------|-----------------|---------|
| | Input | Output |
| R10A · 15A · 25A · 50A | H-IN-3 | H-OU-9 |
| RMB15A · 30A · 50A | | H-OU-16 |
| RMC15A · 30A · 50A | | H-OU-15 |

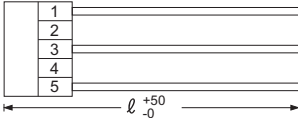
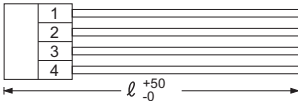
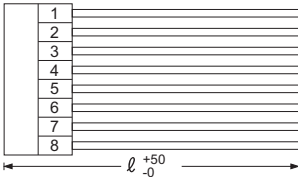
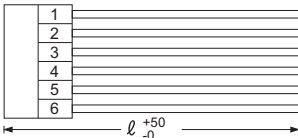
| <p>●Model number H-IN-3</p> <p>Housing : VHR-5N (J.S.T.) Pin : SVH-21T-P1.1 (J.S.T.) Weight : 20g max</p> | <p>●Type</p>  | <p>●Wire</p> <table border="1"> <thead> <tr> <th>Pin #</th> <th>Wire</th> <th>AWG</th> <th>Color</th> <th>Length ℓ (mm)</th> </tr> </thead> <tbody> <tr> <td>1</td> <td>UL1015</td> <td>20</td> <td>white</td> <td>500</td> </tr> <tr> <td>2</td> <td></td> <td></td> <td></td> <td></td> </tr> <tr> <td>3</td> <td>UL1015</td> <td>20</td> <td>black</td> <td>500</td> </tr> <tr> <td>4</td> <td></td> <td></td> <td></td> <td></td> </tr> <tr> <td>5</td> <td>UL1015</td> <td>20</td> <td>green</td> <td>500</td> </tr> </tbody> </table> | Pin # | Wire | AWG | Color | Length ℓ (mm) | 1 | UL1015 | 20 | white | 500 | 2 | | | | | 3 | UL1015 | 20 | black | 500 | 4 | | | | | 5 | UL1015 | 20 | green | 500 | | | | | | | | | | | | | | | |
|---|--|---|--------|---------------|-----|-------|---------------|---|--------|----|--------|-----|---|--------|----|--------|-----|---|--------|----|-------|-----|---|--------|----|--------|-----|---|--------|----|-------|-----|---|--------|----|-------|-----|---|--------|----|-----|-----|---|--------|----|-----|-----|
| Pin # | Wire | AWG | Color | Length ℓ (mm) | | | | | | | | | | | | | | | | | | | | | | | | | | | | | | | | | | | | | | | | | | | |
| 1 | UL1015 | 20 | white | 500 | | | | | | | | | | | | | | | | | | | | | | | | | | | | | | | | | | | | | | | | | | | |
| 2 | | | | | | | | | | | | | | | | | | | | | | | | | | | | | | | | | | | | | | | | | | | | | | | |
| 3 | UL1015 | 20 | black | 500 | | | | | | | | | | | | | | | | | | | | | | | | | | | | | | | | | | | | | | | | | | | |
| 4 | | | | | | | | | | | | | | | | | | | | | | | | | | | | | | | | | | | | | | | | | | | | | | | |
| 5 | UL1015 | 20 | green | 500 | | | | | | | | | | | | | | | | | | | | | | | | | | | | | | | | | | | | | | | | | | | |
| <p>●Model number H-OU-9</p> <p>Housing : VHR-4N (J.S.T.) Pin : SVH-21T-P1.1 (J.S.T.) Weight : 40g max</p> | <p>●Type</p>  | <p>●Wire</p> <table border="1"> <thead> <tr> <th>Pin #</th> <th>Wire</th> <th>AWG</th> <th>Color</th> <th>Length ℓ (mm)</th> </tr> </thead> <tbody> <tr> <td>1</td> <td>UL1015</td> <td>18</td> <td>black</td> <td>500</td> </tr> <tr> <td>2</td> <td>UL1015</td> <td>18</td> <td>black</td> <td>500</td> </tr> <tr> <td>3</td> <td>UL1015</td> <td>18</td> <td>red</td> <td>500</td> </tr> <tr> <td>4</td> <td>UL1015</td> <td>18</td> <td>red</td> <td>500</td> </tr> </tbody> </table> | Pin # | Wire | AWG | Color | Length ℓ (mm) | 1 | UL1015 | 18 | black | 500 | 2 | UL1015 | 18 | black | 500 | 3 | UL1015 | 18 | red | 500 | 4 | UL1015 | 18 | red | 500 | | | | | | | | | | | | | | | | | | | | |
| Pin # | Wire | AWG | Color | Length ℓ (mm) | | | | | | | | | | | | | | | | | | | | | | | | | | | | | | | | | | | | | | | | | | | |
| 1 | UL1015 | 18 | black | 500 | | | | | | | | | | | | | | | | | | | | | | | | | | | | | | | | | | | | | | | | | | | |
| 2 | UL1015 | 18 | black | 500 | | | | | | | | | | | | | | | | | | | | | | | | | | | | | | | | | | | | | | | | | | | |
| 3 | UL1015 | 18 | red | 500 | | | | | | | | | | | | | | | | | | | | | | | | | | | | | | | | | | | | | | | | | | | |
| 4 | UL1015 | 18 | red | 500 | | | | | | | | | | | | | | | | | | | | | | | | | | | | | | | | | | | | | | | | | | | |
| <p>●Model number H-OU-15</p> <p>Housing : VHR-8N (J.S.T.) Pin : SVH-21T-P1.1 (J.S.T.) Weight : 80g max</p> | <p>●Type</p>  | <p>●Wire</p> <table border="1"> <thead> <tr> <th>Pin #</th> <th>Wire</th> <th>AWG</th> <th>Color</th> <th>Length ℓ (mm)</th> </tr> </thead> <tbody> <tr> <td>1</td> <td>UL1015</td> <td>18</td> <td>purple</td> <td>500</td> </tr> <tr> <td>2</td> <td>UL1015</td> <td>18</td> <td>gray</td> <td>500</td> </tr> <tr> <td>3</td> <td>UL1015</td> <td>18</td> <td>gray</td> <td>500</td> </tr> <tr> <td>4</td> <td>UL1015</td> <td>18</td> <td>orange</td> <td>500</td> </tr> <tr> <td>5</td> <td>UL1015</td> <td>18</td> <td>black</td> <td>500</td> </tr> <tr> <td>6</td> <td>UL1015</td> <td>18</td> <td>black</td> <td>500</td> </tr> <tr> <td>7</td> <td>UL1015</td> <td>18</td> <td>red</td> <td>500</td> </tr> <tr> <td>8</td> <td>UL1015</td> <td>18</td> <td>red</td> <td>500</td> </tr> </tbody> </table> | Pin # | Wire | AWG | Color | Length ℓ (mm) | 1 | UL1015 | 18 | purple | 500 | 2 | UL1015 | 18 | gray | 500 | 3 | UL1015 | 18 | gray | 500 | 4 | UL1015 | 18 | orange | 500 | 5 | UL1015 | 18 | black | 500 | 6 | UL1015 | 18 | black | 500 | 7 | UL1015 | 18 | red | 500 | 8 | UL1015 | 18 | red | 500 |
| Pin # | Wire | AWG | Color | Length ℓ (mm) | | | | | | | | | | | | | | | | | | | | | | | | | | | | | | | | | | | | | | | | | | | |
| 1 | UL1015 | 18 | purple | 500 | | | | | | | | | | | | | | | | | | | | | | | | | | | | | | | | | | | | | | | | | | | |
| 2 | UL1015 | 18 | gray | 500 | | | | | | | | | | | | | | | | | | | | | | | | | | | | | | | | | | | | | | | | | | | |
| 3 | UL1015 | 18 | gray | 500 | | | | | | | | | | | | | | | | | | | | | | | | | | | | | | | | | | | | | | | | | | | |
| 4 | UL1015 | 18 | orange | 500 | | | | | | | | | | | | | | | | | | | | | | | | | | | | | | | | | | | | | | | | | | | |
| 5 | UL1015 | 18 | black | 500 | | | | | | | | | | | | | | | | | | | | | | | | | | | | | | | | | | | | | | | | | | | |
| 6 | UL1015 | 18 | black | 500 | | | | | | | | | | | | | | | | | | | | | | | | | | | | | | | | | | | | | | | | | | | |
| 7 | UL1015 | 18 | red | 500 | | | | | | | | | | | | | | | | | | | | | | | | | | | | | | | | | | | | | | | | | | | |
| 8 | UL1015 | 18 | red | 500 | | | | | | | | | | | | | | | | | | | | | | | | | | | | | | | | | | | | | | | | | | | |
| <p>●Model number H-OU-16</p> <p>Housing : VHR-6N (J.S.T.) Pin : SVH-21T-P1.1 (J.S.T.) Weight : 60g max</p> | <p>●Type</p>  | <p>●Wire</p> <table border="1"> <thead> <tr> <th>Pin #</th> <th>Wire</th> <th>AWG</th> <th>Color</th> <th>Length ℓ (mm)</th> </tr> </thead> <tbody> <tr> <td>1</td> <td>UL1015</td> <td>18</td> <td>gray</td> <td>500</td> </tr> <tr> <td>2</td> <td>UL1015</td> <td>18</td> <td>orange</td> <td>500</td> </tr> <tr> <td>3</td> <td>UL1015</td> <td>18</td> <td>black</td> <td>500</td> </tr> <tr> <td>4</td> <td>UL1015</td> <td>18</td> <td>black</td> <td>500</td> </tr> <tr> <td>5</td> <td>UL1015</td> <td>18</td> <td>red</td> <td>500</td> </tr> <tr> <td>6</td> <td>UL1015</td> <td>18</td> <td>red</td> <td>500</td> </tr> </tbody> </table> | Pin # | Wire | AWG | Color | Length ℓ (mm) | 1 | UL1015 | 18 | gray | 500 | 2 | UL1015 | 18 | orange | 500 | 3 | UL1015 | 18 | black | 500 | 4 | UL1015 | 18 | black | 500 | 5 | UL1015 | 18 | red | 500 | 6 | UL1015 | 18 | red | 500 | | | | | | | | | | |
| Pin # | Wire | AWG | Color | Length ℓ (mm) | | | | | | | | | | | | | | | | | | | | | | | | | | | | | | | | | | | | | | | | | | | |
| 1 | UL1015 | 18 | gray | 500 | | | | | | | | | | | | | | | | | | | | | | | | | | | | | | | | | | | | | | | | | | | |
| 2 | UL1015 | 18 | orange | 500 | | | | | | | | | | | | | | | | | | | | | | | | | | | | | | | | | | | | | | | | | | | |
| 3 | UL1015 | 18 | black | 500 | | | | | | | | | | | | | | | | | | | | | | | | | | | | | | | | | | | | | | | | | | | |
| 4 | UL1015 | 18 | black | 500 | | | | | | | | | | | | | | | | | | | | | | | | | | | | | | | | | | | | | | | | | | | |
| 5 | UL1015 | 18 | red | 500 | | | | | | | | | | | | | | | | | | | | | | | | | | | | | | | | | | | | | | | | | | | |
| 6 | UL1015 | 18 | red | 500 | | | | | | | | | | | | | | | | | | | | | | | | | | | | | | | | | | | | | | | | | | | |

Mouser Electronics

Authorized Distributor

Click to View Pricing, Inventory, Delivery & Lifecycle Information:

Cosel:

[F-R25-2](#) [F-R10-1](#) [F-R50-2](#) [H-OU-16](#) [F-R150-1](#) [F-R15-2](#) [H-OU-9](#) [F-R15-1](#) [H-OU-15](#) [F-R100-2](#) [F-R150-2](#) [F-R100-1](#) [F-R25-1](#) [F-R50-1](#) [H-IN-3](#)